

**Coordination between protection and control components****Type of information****Page**

Types of coordination, according to the standard currents in the circuit to be considered

A6/2

Selection of the coordination type

A6/3

**Suggested coordinated Direct-On-Line motor starter combinations**

Fuse + contactors + thermal overload relay

A6/4

Circuit breaker (with built in overload protection) + contactors

A6/9

Circuit breaker + contactors + thermal overload relay

A6/11

**Suggested coordinated Star-delta motor starter combinations**

Fuse + contactors + thermal overload relay

A6/16

Circuit breaker (with built in overload protection) + contactors

A6/19

Circuit breaker + contactors + thermal overload relay

A6/21

**Suggested coordinated TeSys island motor starter combinations**

Protection Components / Starters - Coordination - IEC

A6/25

Protection Components / Starters - SCCR Ratings - UL

A6/32

**Contactors: Utilisation categories – Standard characteristics – Selection tables per categorie**

Definition: utilisation categories : AC-1, AC-2, AC-3, etc...

A6/33

Definition: contactor standard characteristics

A6/34

Contactor selection tables per utilisation categorie

A6/36

**Contactors for specific application – Design information**

Selection of contactors for lighting circuits

A6/50

Selection of contactors for heating circuits

A6/56

Selection of contactors for switching primaries of 3P LV/LV transformers

A6/58

Selection of contactors for switching 3P capacitor banks (factor correction)

A6/59

Selection of contactors auto-transformer starting

A6/60

Selection of contactors for rotor circuit of slip-ring motors

A6/62

Design of long distance remote control for contactors

A6/64

Current of asynchronous squirrel cage motors at nominal load

A6/68

**Standards – Protection against contact – Protective treatments**

International standards and certifications

A6/69

Protection against accidental direct contacts / IP codes

A6/71

#### Type 1 and type 2 coordination according to the standard

The standard defines tests at different levels of current; the purpose of these tests is to place the equipment in extreme conditions.

The standard defines 2 types of coordination, according to the condition of the components after testing:

- type 1,**
- type 2.**

To determine the type of coordination, the standard requires that the behaviour of the equipment be tested under overload and short-circuit conditions for 3 fault current values, covering overload and short-circuit conditions.

#### Type 1 coordination

Type 1 coordination requires that in a short-circuit condition, the contactor or starter must not present any danger to personnel or installations and must not be able to resume operation without repair or the replacement of parts.

#### Type 2 coordination

Type 2 coordination requires that in a short-circuit condition, the contactor or starter must not present any danger to personnel or installations and must subsequently be able to resume operation. The risk of contact welding is permissible; in this case, the manufacturer must indicate measures to be taken regarding maintenance of the equipment.

Type 2 coordination increases reliability of operation.

#### Current values

##### Current "Ico" (overload $I < 10 I_n$ )

The thermal overload relay associated with the contactor provides protection against this type of fault, up to a value  $I_{co}$  (see curve) defined by the manufacturer.

Standard IEC 60947-4-1 specifies the 2 current values to be used for checking coordination between the thermal overload relay and the short-circuit protection device:

- at  $0.75 I_{co}$  only the thermal overload relay must trip,
- at  $1.25 I_{co}$  the short-circuit protection device must operate.

##### Current "r" (low level short-circuit $10 < I < 50 I_n$ )

The main cause of this type of fault is the deterioration of insulating materials. Standard IEC 60947-4-1 defines an intermediate short-circuit current "r". This test current makes it possible to check whether the protection device is providing protection against low-level short-circuits.

Operational current $I_e$ (AC-3) (A)	Current "r" (kA)
$I_e \leq 16$	1
$16 < I_e \leq 63$	3
$63 < I_e \leq 125$	5
$125 < I_e \leq 315$	10
$315 < I_e \leq 630$	18
$630 < I_e \leq 1000$	30

##### Current "Iq" (short-circuit $>$ current "r")

This type of fault corresponds to a dead short and is relatively rare. It can be caused by a connection error during maintenance work. Short-circuit protection is provided by fast operating devices.

Standard IEC 60947-4-1 defines a current "Iq". The coordination tables supplied by Schneider Electric are based on a current "Iq" that is generally  $\geq 50$  kA.

(1) SCPD: short-circuit protection device.

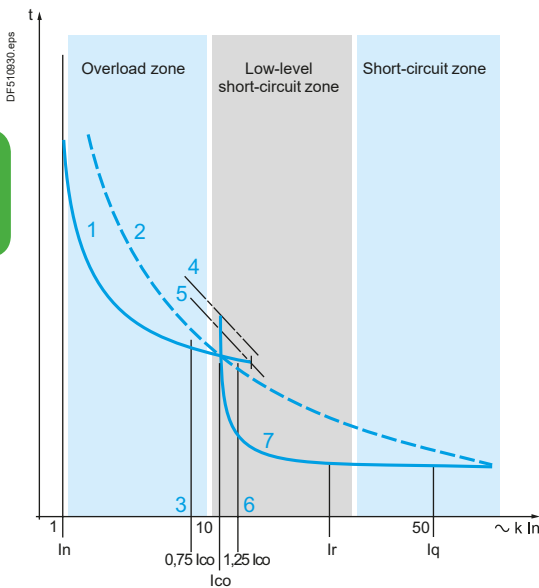

- 1 Thermal overload relay curve.
- 2 Fuse.
- 3 Tripping of thermal overload relay only.
- 4 Thermal limit of the circuit breaker.
- 5 Thermal overload relay limit.
- 6 Current broken by the SCPD (1).
- 7 Circuit breaker magnetic trip.

#### Selection

##### No coordination

**Considerable risks to both persons and equipment.**

Not authorised by standards:

- NF C 15-100 and IEC 60364-1, article 133-1 (installation regulations),
- EN/IEC 60204-1, article 7 (electrical equipment in machines),
- IEC 60947-4-1, article 8.2.5. (starters)

##### Type 1 coordination

**The most frequently used solution.**

- Equipment costs are lower.
- Reliability of operation is not a requirement.
- Before restarting, it may be necessary to repair the motor starter.

Consequences:

- significant amount of machine downtime,
- skilled maintenance personnel required to repair, check, obtain supplies.

Example: air conditioning in commercial premises.

##### Type 2 coordination

**This solution ensures reliability of operation.**

Consequences:

- reduced machine downtime,
- reduced maintenance after a short-circuit.

Example: escalators.

##### Total coordination

**With this solution, no damage or misadjustment is permissible and reliability of operation is guaranteed.**

Consequences:

- immediate return to service,
- no special precautions required.

Examples: smoke extraction, fire-fighting pumps.

0.06 to 55 kW at 400/415 V: type 1 coordination											
Standard power ratings of 3-phase motors 50/60 Hz in category AC-3						Fuse carrier <sup>(1)</sup> (basic block)	aM fuses		Contactor	Thermal overload relay class 10	
400/415 V		440 V		500 V		Reference	Size	Rating	Reference <sup>(2)</sup>	Reference	Setting range
P	I <sub>e</sub>	P	I <sub>e</sub>	P	I <sub>e</sub>			A			A
kW	A	kW	A	kW	A						A
0.06	0.2	0.06	0.19	–	–	LS1D32	10 x 38	2	LC1K06	LR2K0302	0.16...0.23
–	–	0.09	0.28	–	–	LS1D32	10 x 38	2	LC1K06	LR2K0303	0.23...0.36
0.09	0.3	–	–	–	–	LS1D32	10 x 38	2	LC1K06	LR2K0304	0.36...0.54
0.12	0.44	0.12	0.37	–	–	LS1D32	10 x 38	2	LC1K06	LR2K0304	0.36...0.54
0.18	0.6	0.18	0.55	–	–	LS1D32	10 x 38	2	LC1K06	LR2K0305	0.54...0.8
–	–	0.25	0.76	–	–	LS1D32	10 x 38	2	LC1K06	LR2K0305	0.54...0.8
0.25	0.85	–	–	–	–	LS1D32	10 x 38	2	LC1K06	LR2K0306	0.8...1.2
0.37	1.1	0.37	1	0.37	0.88	LS1D32	10 x 38	2	LC1K06	LR2K0306	0.8...1.2
0.55	1.5	0.55	1.36	0.55	1.2	LS1D32	10 x 38	2	LC1K06	LR2K0307	1.2...1.8
–	–	0.75	1.68	0.75	1.5	LS1D32	10 x 38	2	LC1K06	LR2K0307	1.2...1.8
0.75	1.9	–	–	1.1	2.2	LS1D32	10 x 38	4	LC1K06	LR2K0308	1.8...2.6
1.1	2.7	1.1	2.37	1.5	2.9	LS1D32	10 x 38	4	LC1K06	LR2K0308	1.8...2.6
1.5	3.6	1.5	3.06	–	–	LS1D32	10 x 38	4	LC1K06	LR2K0310	2.6...3.7
2.2	4.9	–	–	2.2	3.9	LS1D32	10 x 38	6	LC1K06	LR2K0312	3.7...5.5
–	–	–	–	3	5.2	LS1D32	10 x 38	6	LC1K06	LR2K0312	3.7...5.5
–	–	2.2	4.42	–	–	LS1D32	10 x 38	8	LC1K06	LR2K0312	3.7...5.5
3	6.5	3	5.77	4	6.8	LS1D32	10 x 38	8	LC1K09	LR2K0314	5.5...8
4	8.5	4	7.9	5.5	9.2	LS1D32	10 x 38	12	LC1K09	LR2K0316	8...11.5

(1) For breaking under load, add a rotary switch-disconnector.

(2) For reversing operation, replace the prefix LC1 with LC2.

0.06 to 55 kW at 400/415 V: type 1 coordination											
Standard power ratings of 3-phase motors 50/60 Hz in category AC-3						Fuse carrier <sup>(1)</sup> (basic block)	aM fuses		Contactor	Thermal overload relay classe 10	
400/415 V		440 V		500 V		Reference	Size	Rating	Reference <sup>(2)</sup>	Reference	Setting range
P	I <sub>e</sub>	P	I <sub>e</sub>	P	I <sub>e</sub>			A			A
kW	A	kW	A	kW	A						A
5.5	11.5	5.5	10.4	7.5	12.4	LS1D32	10 x 38	16	LC1K12	LR2K0321	10...14
7.5	15.5	7.5	13.7	9	13.9	LS1D32	10 x 38	16	LC1D18	LRD21	12...18
-	-	9	16.9	-	-	LS1D32	10 x 38	20	LC1D25	LRD21	12...18
9	18.1	-	-	11	17.6						
11	22	11	20.1	15	23	GK1EK	14 x 51	25	LC1D25	LRD22	16...24
15	29	15	26.5	18.5	28	GK1EK	14 x 51	32	LC1D32	LRD32	23...32
18.5	35	18.5	32.8	22	33	GK1EK	14 x 51	40	LC1D40A	LRD340	30...40
22	41	22	39	30	44	GS●J	22 x 58	50	LC1D50A	LRD350	37...50
-	-	30	51.5	-	-	GS●J	22 x 58	80	LC1D50A	LRD365	48...65
-	-	-	-	37	53	GS●J	22 x 58	80	LC1D65A	LRD365	48...65
30	55	37	64	-	-	GS●J	22 x 58	80	LC1D65A	LRD365	48...65
-	-	-	-	45	64	GS●J	22 x 58	80	LC1D80	LRD3361	55...70
37 <sup>(3)</sup>	66	45	76	-	-	GS●J	22 x 58	100	LC1D80	LRD3363	63...80
45	80	-	-	55	78	GS●J	22 x 58	100	LC1D95	LRD3365	80...93
-	-	55	90	-	-	GS●J	22 x 58	125	LC1D115	LRD4365	80...104
55	97	-	-	75	106	GS●J	22 x 58	125	LC1D115	LRD4367	95...120

(1) For breaking under load, add a rotary switch-disconnector.

(2) For reversing operation, replace the prefix LC1 with LC2.

(3) 400 V maximum.

0.06 to 315 kW at 400/415 V: type 2 coordination											
Standard power ratings of 3-phase motors 50/60 Hz in category AC-3						Switch-disconnector	aM fuses		Contactor	Thermal overload relay classe 10	
400/415 V		440 V		500 V		Reference <sup>(1)</sup>	Size	Rating	Reference <sup>(2)</sup>	Reference	Setting range
P	I <sub>e</sub>	P	I <sub>e</sub>	P	I <sub>e</sub>			A			A
kW	A	kW	A	kW	A						
0.06	0.2	0.06	0.19	–	–	GS1DD	10 x 38	2	LC1D09	LRD02	0.16...0.25
–	–	0.09	0.28	–	–	GS1DD	10 x 38	2	LC1D09	LRD03	0.25...0.4
0.09	0.3	–	–	–	–						
0.12	0.44	0.12	0.37	–	–	GS1DD	10 x 38	2	LC1D09	LRD04	0.4...0.63
0.18	0.6	0.18	0.55	–	–						
–	–	0.25	0.76	–	–	GS1DD	10 x 38	2	LC1D09	LRD05	0.63...1
0.25	0.85	–	–	0.37	0.88						
0.37	1.1	0.37	1	0.55	1.2						
0.55	1.5	0.55	1.36	0.75	1.5	GS1DD	10 x 38	2	LC1D09	LRD06	1...1.7
0.75	1.9	0.75	1.68	–	–						
–	–	1.1	2.37	1.1	2.2	GS1DD	10 x 38	4	LC1D09	LRD07	1.6...2.5
1.1	2.7	–	–	1.5	2.9						
1.5	3.6	1.5	3.06	2.2	3.9	GS1DD	10 x 38	4	LC1D09	LRD08	2.5...4
2.2	4.9	2.2	4.42	3	5.2	GS1DD	10 x 38	6	LC1D09	LRD10	4...6
3	6.5	3	5.77	4	6.8	GS1DD	10 x 38	8	LC1D09	LRD12	5.5...8
4	8.5	4	7.9	5.5	9.2	GS1DD	10 x 38	10	LC1D09	LRD14	7...10
5.5	11.5	5.5	10.4	7.5	12.4	GS1DD	10 x 38	16	LC1D12	LRD16	9...13
7.5	15.5	7.5	13.7	9	13.9	GS1DD	10 x 38	16	LC1D18	LRD21	12...18
–	–	9	16.9	–	–	GS●F	14 x 51	20	LC1D25	LRD21	12...18
9	18.1	11	20.1	11	17.6						
11	22	–	–	15	23	GS●F	14 x 51	25	LC1D25	LRD22	16...24
15	29	15	26.5	18.5	28	GS●F	14 x 51	32	LC1D32	LRD32	23...32
18.5	35	18.5	32.8	22	33	GS●F	14 x 51	40	LC1D40A	LRD340	30...40
22	41	22	39	30	44	GS●J	22 x 58	50	LC1D50A	LRD350	37...50
–	–	30	51.5	–	–	GS●J	22 x 58	80	LC1D65A	LRD365	48...65
–	–	–	–	37	53	GS●J	22 x 58	80	LC1D65A	LRD365	48...65
30	55	37	64	–	–	GS●J	22 x 58	80	LC1D65A	LRD365	48...65
–	–	–	–	45	64	GS●J	22 x 58	80	LC1D95	LRD3361	55...70
37	66	45	76	–	–	GS●J	22 x 58	100	LC1D80	LRD3363	63...80
–	–	–	–	55	78	GS●J	22 x 58	100	LC1D115	LR9D5367	60...100
45	80	–	–	–	–	GS●J	22 x 58	100	LC1D95	LRD3365	80...93
55	97	55	90	75	106	GS●L	T0	125	LC1D150	LR9D5369	90...150
75	132	75	125	90	128	GS●L	T0	160	LC1D150	LR9D5369	90...150
90	160	90	146	110	156	GS●N	T1	200	LC1F185	LR9F5371	132...220
110	195	110	178	132	184	GS●N	T1	250	LC1F225	LR9F5371	132...220
132	230	132	215	160	224	GS●QQ	T2	315	LC1F265	LR9F7375	200...330
–	–	160	256	–	–	GS●QQ	T2	315	LC1F330	LR9F7375	200...330
160	280	200	321	200	280	GS●QQ	T2	400	LC1F330	LR9F7375	200...330
–	–	–	–	220	310	GS●QQ	T2	400	LC1F400	LR9F7375	200...330
200	350	–	–	–	–						
220	388	220	353	250	344	GS2S	T3	500	LC1F400	LR9F7379	300...500
250	430	250	401	–	–	GS2S	T3	500	LC1F500	LR9F7379	300...500
–	–	–	–	315	432						
–	–	–	–	355	488	GS2S	T3	630	LC1F500	LR9F7381	380...630
315	540	315	505	–	–	GS2S	T3	630	LC1F630	LR9F7381	380...630
–	–	355	549	–	–						
–	–	400	611	400	552	GS2V	T4	800	LC1F630	LR9F7381	380...630

(1) GS●: GS1 for direct operator or GS2 for external operator.

(2) For reversing operation, replace the prefix LC1 with LC2.

0.75 to 400 kW at 690 V: type 2 coordination							
Standard power ratings of 3-phase motors 50/60 Hz in category AC-3		Switch-disconnector	aM fuses		Contactor	Thermal overload relay classe 10	
P	I <sub>e</sub>	Reference <sup>(1)</sup>	Size	Rating	Reference <sup>(2)</sup>	Reference	Setting range
kW	A			A			A
0.75	1.1	GS●F	14 x 51	2	LC1D09	LRD06	1...1.6
1.1	1.6	GS●F	14 x 51	2	LC1D09	LRD06	1...1.6
1.5	2.1	GS●F	14 x 51	4	LC1D09	LRD07	1.6...2.5
2.2	2.8	GS●F	14 x 51	4	LC1D09	LRD08	2.5...4
3	3.8	GS●F	14 x 51	6	LC1D09	LRD08	2.5...4
4	4.9	GS●F	14 x 51	6	LC1D09	LRD10	4...6
5.5	6.7	GS●F	14 x 51	8	LC1D09	LRD12	5.5...8
7.5	8.9	GS●F	14 x 51	10	LC1D25	LRD16	9...13
11	12.8	GS●F	14 x 51	16	LC1D25	LRD16	9...13
15	17	GS●F	14 x 51	20	LC1D25	LRD22	16...24
18.5	21	GS●F	14 x 51	25	LC1D32	LRD22	16...24
22	24	GS●J	22 x 58	32	LC1D40A	LRD332	23...32
30	32	GS●J	22 x 58	40	LC1D40A	LRD340	30...40
37	39	GS●J	22 x 58	50	LC1D65A	LRD350	37...50
45	47	GS●J	22 x 58	63	LC1D80	LRD3357	37...50
55	57	GS●J	22 x 58	80	LC1D115	LRD3359	48...65
75	77	GS●KK	T00	100	LC1D115	LRD3363	63...80
90	93	GS●KK	T00	125	LC1D150	LR9D5369	90...150
110	113	GS●KK	T00	125	LC1F185	LR9D5369	90...150
132	134	GS●L	T0	160	LC1F265	LR9F5371	132...220
160	162	GS●N	T1	200	LC1F265	LR9F5371	132...220
200	203	GS●N	T1	250	LC1F330	LR9F7375	200...330
220	224	GS●QQ	T2	250	LC1F400	LR9F7375	200...330
250	250	GS●QQ	T2	315	LC1F400	LR9F7375	200...330
315	313	GS●QQ	T2	355	LC1F500	LR9F7379	300...500
355	354	GS●QQ	T2	400	LC1F630	LR9F7379	300...500
400	400	GS2S	T3	500	LC1F630	LR9F7379	300...500

(1) GS●: GS1 for direct operator or GS2 for external operator.

(2) For reversing operation, replace the prefix LC1 with LC2.

0.18 to 55 kW at 400/415 V: type 2 coordination											
Standard power ratings of 3-phase motors 50/60 Hz in category AC-3						Switch- disconnect	aM fuses		Contactor	Electronic thermal overload relay	
400/415 V			690 V				Reference	Size		Rating	Reference
P	I <sub>e</sub>	I <sub>q</sub>	P	I <sub>e</sub>	I <sub>q</sub>						
kW	A	kA	kW	A	kA			A			A
0.18	0.6	100	–	–	–	GS1DD	10 x 38	2	LC1D09	LR9D02	0.4...2.0
0.25	0.85	100	–	–	–	GS1DD	10 x 38	2	LC1D09	LR9D02	0.4...2.0
0.37	1.1	100	–	–	–	GS1DD	10 x 38	2	LC1D09	LR9D02	0.4...2.0
0.55	1.5	100	–	–	–	GS1DD	10 x 38	2	LC1D09	LR9D02	0.4...2.0
0.75	1.9	100	–	–	–	GS1DD	10 x 38	4	LC1D09	LR9D02	0.4...2.0
1.1	2.7	100	–	–	–	GS1DD	10 x 38	4	LC1D18	LR9D08	1.6...8.0
1.5	3.6	100	–	–	–	GS1DD	10 x 38	4	LC1D18	LR9D08	1.6...8.0
2.2	4.9	100	–	–	–	GS1DD	10 x 38	6	LC1D18	LR9D08	1.6...8.0
3	6.5	100	–	–	–	GS1DD	10 x 38	8	LC1D18	LR9D32	6.4...32
4	8.5	100	–	–	–	GS1DD	10 x 38	10	LC1D18	LR9D32	6.4...32
5.5	11.5	100	–	–	–	GS1DD	10 x 38	16	LC1D25	LR9D32	6.4...32
7.5	15.5	50	–	–	–	GS1DD	10 x 38	16	LC1D25	LR9D32	6.4...32
11	22	50	–	–	–	GS●F	14 x 51	25	LC1D25	LR9D32	6.4...32
15	29	50	–	–	–	GS●J	22 x 58	32	LC1D65A	LR9D110S	22...110
18.5	35	50	–	–	–	GS●J	22 x 58	40	LC1D65A	LR9D110S	22...110
22	41	50	–	–	–	GS●J	22 x 58	50	LC1D65A	LR9D110S	22...110
45 <sup>(1)</sup>	80	100	–	–	–	GS●N	T 1	100	LC1D150	LR9D110S	22...110
55 <sup>(1)</sup>	97	100	–	–	–	GS●N	T 1	125	LC1D150	LR9D110S	22...110
–	–	–	0.37	0.64	100	GS●F	14 x 51	2	LC1D09	LR9D02	0.4...2.0
–	–	–	0.55	0.87	100	GS●F	14 x 51	2	LC1D09	LR9D02	0.4...2.0
–	–	–	0.75	1.1	100	GS●F	14 x 51	2	LC1D09	LR9D02	0.4...2.0
–	–	–	1.1	1.6	100	GS●F	14 x 51	2	LC1D25	LR9D08	1.6...8.0
–	–	–	1.5	2.1	100	GS●F	14 x 51	4	LC1D25	LR9D08	1.6...8.0
–	–	–	2.2	2.8	100	GS●F	14 x 51	4	LC1D25	LR9D08	1.6...8.0
–	–	–	3	4	100	GS●F	14 x 51	6	LC1D25	LR9D08	1.6...8.0
–	–	–	4	5	100	GS●F	14 x 51	6	LC1D25	LR9D08	1.6...8.0
–	–	–	5.5	7	50	GS●F	14 x 51	8	LC1D25	LR9D32	6.4...32
–	–	–	7.5	8.9	50	GS●F	14 x 51	10	LC1D25	LR9D32	6.4...32
–	–	–	11	13	50	GS●F	14 x 51	16	LC1D32	LR9D32	6.4...32
–	–	–	15	16.5	50	GS●F	14 x 51	20	LC1D32	LR9D32	6.4...32
–	–	–	18.5	21	100	GS●F	14 x 51	25	LC1D95	LR9D32	6.4...32
–	–	–	18.5	21	50	GS●F	14 x 51	25	LC1D65A	LR9D32	6.4...32
–	–	–	22	25	50	GS●F	14 x 51	32	LC1D65A	LR9D32	6.4...32
–	–	–	30	33	100	GS●F	14 x 51	40	LC1D95	LR9D110	22...110
–	–	–	37	40	100	GS●F	14 x 51	50	LC1D95	LR9D110	22...110
–	–	–	45	49	100	GS●J	22 x 58	63	LC1D95	LR9D110	22...110

(1) Ratings valid up to 400 V AC only.

Coordination  
and  
standards



0.06 to 375 kW at 415 V: type 2 coordination											
Standard power ratings of 3-phase motors 50/60 Hz in category AC-3						Switch-disconnector-fuse	BS fuses		Contactor	Thermal overload relay	
415 V		440 V		500 V		Reference	Size	Rating	Reference <sup>(1)</sup>	Reference	Setting range
P	I <sub>e</sub>	P	I <sub>e</sub>	P	I <sub>e</sub>						
kW	A	kW	A	kW	kA		A			A	
0.06	0.22	0.06	0.19	–	–	GS1DDB	A1	NIT 2	LC1D09	LRD02	0.16...0.25
–	–	0.09	0.28	–	–	GS1DDB	A1	NIT 2	LC1D09	LRD03	0.25...0.4
0.09	0.36	–	–	–	–						
0.12	0.42	0.12	0.37	–	–	GS1DDB	A1	NIT 2	LC1D09	LRD04	0.4...0.63
0.18	0.6	0.18	0.55	–	–	GS1DDB	A1	NIT 2	LC1D09	LRD05	0.63...1
–	–	0.25	0.76	–	–	GS1DDB	A1	NIT 4	LC1D09	LRD05	0.63...1
0.25	0.88	0.37	1	0.37	1						
0.37	1	0.55	1.36	0.55	1.2						
0.55	1.5	0.75	1.68	0.75	1.5	GS1DDB	A1	NIT 6	LC1D09	LRD06	1...1.7
0.75	2	–	–	–	–	GS1DDB	A1	NIT 10	LC1D09	LRD07	1.6...2.5
–	–	–	–	1.5	2.6	GS1DDB	A1	NIT 10	LC1D09	LRD08	2.5...4
1.5	3.5	1.5	3.06	2.2	3.8	GS1DDB	A1	NIT 16	LC1D09	LRD08	2.5...4
2.2	5	2.2	4.42	3	5	GS1DDB	A1	NIT 16	LC1D09	LRD10	4...6
3	6.5	3	5.77	4	6.5	GS1DDB	A1	NIT 20	LC1D09	LRD12	5.5...8
4	8.4	4	7.9	5.5	9	GS1DDB	A1	NIT 20	LC1D09	LRD14	7...10
5.5	11	5.5	10.4	7.5	12	GS1DDB	A1	NIT 20M25	LC1D12	LRD16	9...13
7.5	14	7.5	13.7	9	13.9	GS1DDB	A1	NIT 20M32	LC1D18	LRD21	12...18
9	18.1	9	16.9	–	–	GS2GB	A2	TIA 32M35	LC1D18	LRD21	12...18
11	21	11	20	11	18.4						
–	–	–	–	15	23	GS2GB	A2	TIA 32M50	LC1D25	LRD22	16...24
15	28.5	15	26.5	–	–	GS2GB	A2	TIA 32M63	LC1D32	LRD32	23...32
18.5	35	18.5	32.8	–	–	GS2GB	A3	TIS 63M80	LC1D40A	LRD340	25...40
22	41	22	39	–	–	GS2GB	A3	TIS 63M80	LC1D50A	LRD350	37...50
30	55	30	51.5	–	–	GS2GB	A3	TIS 63M100	LC1D65A	LRD365	48...65
–	–	37	64	–	–	GS2GB	A3	TIS 63M100	LC1D65A	LRD365	48...65
–	–	45	76	45	65	GS2LLB	A4	TCP 100M125	LC1D80	LRD3363	63...80
45	81	–	–	55	80	GS2LLB	A4	TCP 100M125	LC1D95	LRD3365	80...93
55	100	–	–	–	–	GS2LLB	A4	TCP 100M160	LC1D115	LR9D5369	90...150
–	–	55	90	–	–	GS2LLB	A4	TCP 100M160	LC1D115	LR9D5367	60...100
–	–	–	–	80	116	GS2LB	B2	TF 200	LC1D150	LR9D5369	90...150
80	138	80	132	–	–	GS2LB	B2	TF 200M250	LC1D150	LR9D5369	90...150
–	–	–	–	100	143						
–	–	–	–	110	156	GS2LB	B2	TF 200M250	LC1F185	LR9F5371	132...220
100	182	100	162	–	–	GS2MMB	B2	TF 200M250	LC1F185	LR9F5371	132...220
110	196	110	178	–	–	GS2MMB	B2	TF 200M315	LC1F225	LR9F5371	132...220
–	–	–	–	140	200	GS2NB	B3	TKF 315M355	LC1F265	LR9F5371	132...220
140	250	140	226	160	220	GS2NB	B3	TKF 315M355	LC1F265	LR9F7375	200...330
160	285	160	256	–	–	GS2QQB	B4	TKF 315M355	LC1F330	LR9F7375	200...330
–	–	–	–	220	310	GS2QQB	B4	TMF 400	LC1F400	LR9F7379	300...500
220	388	220	353	257	362	GS2QQB	B4	TMF 400M450	LC1F400	LR9F7379	300...500
–	–	–	–	270	380	GS2SB	C2	TTM 500	LC1F500	LR9F7379	300...500
257	450	257	412	–	–						
270	460	270	433	–	–	GS2SB	C2	TTM 500	LC1F500	LR9F7381	380...630
375	610	375	577	375	508						
–	–	–	–	425	556	GS2SB	C2	TTM 630	LC1F630	LR9F7381	380...630

(1) For reversing operation, replace the prefix LC1 with LC2.

0.06 to 250 kW at 400/415 V: type 1 coordination												
Standard power ratings of 3-phase motors 50/60 Hz in category AC-3									Circuit breaker		Contactor	
400/415 V			440 V			500 V			Reference	Setting range	Reference <sup>(2)</sup>	
P	I <sub>e</sub>	I <sub>q</sub> <sup>(1)</sup>	P	I <sub>e</sub>	I <sub>q</sub> <sup>(1)</sup>	P	I <sub>e</sub>	I <sub>q</sub> <sup>(1)</sup>	References in italics are available in CEE zone only	of thermal trips		
kW	A	kA	kW	A	kA	kW	A	kA		A		
0.06	0.2	50	0.06	0.19	50	–	–	–	GV2ME02 GV2ME02AP	0.16...0.25	LC1K06 or LC1D09	
0.09	0.3	50	0.09 0.12	0.28 0.37	50 50	–	–	–	GV2ME03 GV2ME03AP	0.25...0.40	LC1K06 or LC1D09	
0.12	0.44	50	–	–	–	–	–	–	GV2ME04 GV2ME04AP	0.40...0.63	LC1K06 or LC1D09	
0.18	0.6	50	0.18	0.55	50	–	–	–	GV2ME05 GV2ME05AP	0.63...1	LC1K06 or LC1D09	
0.25	0.85	50	0.25	0.76	50	–	–	–	GV2ME06 GV2ME06AP	1...1.6	LC1K06 or LC1D09	
0.37	1.1	50	0.37	0.99	50	–	–	–	GV2ME06 GV2ME06AP	1...1.6	LC1K06 or LC1D09	
–	–	–	–	–	–	0.37	0.88	50	GV2ME07 GV2ME07AP	1.6...2.5	LC1K06 or LC1D09	
0.55	1.5	50	0.55	1.36	50	0.55	1.2	50	GV2ME08 GV2ME08AP	2.5...4	LC1K06 or LC1D09	
–	–	–	–	–	–	0.75	1.5	50	GV2ME10 GV2ME10AP	4...6.3	LC1K06 or LC1D09	
0.75	1.9	50	0.75	1.68	50	–	–	–	GV2ME14 GV2ME14AP	6...10	LC1K09 or LC1D09	
–	–	–	1.1	2.37	50	1.1	2.2	50	GV2ME16 GV2ME16AP	9...14	LC1K12 or LC1D12	
1.1	2.7	50	–	–	–	1.5	2.9	50	GV2ME20 GV2ME20AP	13...18	LC1D18	
1.5	3.6	50	1.5	3.06	50	2.2	3.9	50	GV2ME21 GV2ME21AP	17...23	LC1D25	
2.2	4.9	50	2.2	4.42	50	–	–	–	GV2ME22 GV2ME22AP	20...25	LC1D25	
–	–	–	3	5.77	50	3	5.2	50	GV2ME32 GV2ME32AP	24...32	LC1D32	
3	6.5	50	–	–	–	4	6.8	10	GV3P40	30...40	LC1D40A	
4	8.5	50	4	7.9	15	5.5	9.2	10	GV3P50	37...50	LC1D50A	
5.5	11.5	15	5.5	10.4	8	7.5	12.4	6	GV3P65	48...65	LC1D65A	
7.5	15.5	15	7.5	13.7	8	9	13.9	6	GV3P73	62...73	LC1D80A	
–	–	–	9	16.9	8	–	–	–	GV4P80	40...80	LC1D65A	
9	18.1	15	11	20.1	6	11	17.6	4	GV4P80	40...80	LC1D80	
11	22	15	–	–	–	15	23	4	GV4P115	65...115	LC1D95	
15	29	10	15	26.5	6	18.5	28	4	GV4P115	65...115	LC1D115	
18.5	35	50	18.5	32.8	50	22	33	10	GV5P150F	70...150	LC1D150	
22	41	50	22	39	50	30	44	10	GV5P150F	70...150	LC1F185	
30	55	50	30	51.5	50	37	53	10	GV5P220F	100...220	LC1F185	
37	66	50	–	–	–	–	–	–	GV5P220F	100...220	LC1F225	
–	–	–	37	64	70	45	64	30	GV6P320F	160...320	LC1F330	
37	66	100	45	76	70	55	78	30	GV6P320F	160...320	LC1F400	
45	80	100	–	–	–	–	–	–	GV6P500F	250...500	LC1F400	
55	97	100	55	90	70	75	106	30	GV6P500F	250...500	LC1F500	
75	132	36	75	125	35	90	128	30				
–	–	–	90	146	35	–	–	–				
90	160	36	–	–	–	110	156	30				
110	195	36	–	–	–	–	–	–				
160	280	36	318	280	35	–	–	–				
–	–	–	–	–	–	220	308	30				
200	350	36	220	318	35	–	–	–				
250	430	36	250	401	35	335	460	30				

(1) The breaking performance of circuit breakers GV2ME can be increased by adding a current limiter GV1L3.

(2) For reversing operation, replace the prefix LC1 with LC2.

0.06 to 250 kW at 400/415 V: type 2 coordination										Circuit breaker Reference <i>References in italics are available in CEE zone only</i>	Setting range of thermal trips A	Contactor Reference <sup>(2)</sup>
Standard power ratings of 3-phase motors 50/60 Hz in categ or y AC-3												
400/415 V			440 V			500 V						
P	I <sub>e</sub>	I <sub>q</sub> <sup>(1)</sup>	P	I <sub>e</sub>	I <sub>q</sub> <sup>(1)</sup>	P	I <sub>e</sub>	I <sub>q</sub> <sup>(1)</sup>				
kW	A	kA	kW	A	kA	kW	A	kA				
0.06	0.2	130	0.06	0.19	130	–	–	–	–	GV2P02 or GV2ME02 or GV2ME02AP	0.16...0.25	LC1D09
–	–	–	0.09	0.28	130	–	–	–	–	GV2P03 or GV2ME03 or GV2ME03AP	0.25...0.4	LC1D09
0.09	0.3	130	0.12	0.37	130	–	–	–	–	GV2P04 or GV2ME04 or GV2ME04AP	0.4...0.63	LC1D09
0.12	0.44	130	–	–	–	–	–	–	–	GV2P05 or GV2ME05 or GV2ME05AP	0.63...1	LC1D09
0.18	0.6	130	0.18	0.55	130	–	–	–	–	–	–	–
0.25	0.85	130	0.25	0.76	130	–	–	–	–	–	–	–
0.37	1.1	130	0.37	0.99	130	–	–	–	–	–	–	–
–	–	–	–	–	–	0.37	0.88	130	–	GV2P06 or GV2ME06 or GV2ME06AP	1...1.6	LC1D09
0.55	1.5	130	0.55	1.36	130	0.55	1.2	130	–	GV2P06 or GV2ME06 or GV2ME06AP	1...1.6	LC1D09
–	–	–	–	–	–	0.75	1.5	130	–	GV2P06 or GV2ME06 or GV2ME06AP	1...1.6	LC1D09
0.75	1.9	130	0.75	1.68	130	–	–	–	–	GV2P07 or GV2ME07 or GV2ME07AP	1.6...2.5	LC1D09
–	–	–	1.1	2.37	130	1.1	2.2	130	–	GV2P08 or GV2ME08 or GV2ME08AP	2.5...4	LC1D09
1.1	2.7	130	–	–	–	1.5	2.9	130	–	GV2P08 or GV2ME08 or GV2ME08AP	2.5...4	LC1D09
1.5	3.6	130	1.5	3.06	130	2.2	3.9	130	–	–	–	–
–	–	–	–	–	–	–	–	–	–	GV2P10 or GV2ME10 or GV2ME10AP	4...6.3	LC1D09
2.2	4.9	130	–	–	–	–	–	–	–	GV2P10 or GV2ME10 or GV2ME10AP	4...6.3	LC1D09
–	–	–	2.2	4.42	50	–	–	–	–	GV2ME10 or GV2ME10AP	4...6.3	LC1D09
–	–	–	3	5.77	50	3	5.2	50	–	–	–	–
–	–	–	2.2	4.42	130	–	–	–	–	GV2P10	4...6.3	LC1D09
–	–	–	3	5.77	130	3	5.2	130	–	–	–	–
3	6.5	130	–	–	–	–	–	–	–	GV2P14 or GV2ME14 or GV2ME14AP	6...10	LC1D09
4	8.5	130	–	–	–	–	–	–	–	GV2P14 or GV2ME14 or GV2ME14AP	6...10	LC1D09
–	–	–	4	7.9	15	4	6.8	10	–	GV2ME14 or GV2ME14AP	6...10	LC1D09
–	–	–	–	–	–	5.5	9.2	10	–	–	–	–
–	–	–	–	–	–	4	6.8	50	–	GV2P14	6...10	LC1D12
–	–	–	4	7.9	130	5.5	9.2	50	–	–	–	–
5.5	11.5	130	5.5	10.4	50 or 8	7.5	12.4	42 or 6	–	GV2P16 or GV2ME16 or GV2ME16AP	9...14	LC1D25
–	–	–	7.5	13.7	50 or 8	9	13.9	42 or 6	–	–	–	–
7.5	15.5	50 or 15	9	16.9	20 or 8	–	–	–	–	GV2P20 or GV2ME20 or GV2ME20AP	13...18	LC1D25
9	18.1	50 or 15	11	20.1	20 or 8	11	17.6	10 or 6	–	GV2P21 or GV2ME21 or GV2ME21AP	17...23	LC1D25
11	22	50 or 15	–	–	–	–	–	–	–	GV2P22 or GV2ME22 or GV2ME22AP	20...25	LC1D25
–	–	–	–	–	–	15	23	10 or 6	–	GV2P22	20...25	LC1D32
15	29	50 or 10	15	26.5	20 or 6	18.5	28	10 or 4	–	GV2P32 or GV2ME32 or GV2ME32AP	24...32	LC1D32
18.5	35	50	–	–	–	–	–	–	–	GV3P40	30...40	LC1D50A
–	–	–	18.5	32.8	50	22	33	10	–	GV3P40	30...40	LC1D65A
22	41	50	–	–	–	–	–	–	–	GV3P50	37...50	LC1D50A
–	–	–	22	39	50	30	44	10	–	GV3P50	37...50	LC1D65A
30	55	50	30	51.5	50	–	–	–	–	GV3P65	48...65	LC1D65A
–	–	–	–	–	–	37	53	10	–	GV3P65	48...65	LC1D65A
37	66	50	–	–	–	–	–	–	–	GV3P73	62...73	LC1D80A
–	–	–	37	64	70	–	–	–	–	GV4P80	40...80	LC1D65A
37	66	100	45	76	70	<sup>(3)</sup>	<sup>(3)</sup>	<sup>(3)</sup>	–	GV4P80	40...80	LC1D80
45	80	100	55	90	70	<sup>(3)</sup>	<sup>(3)</sup>	<sup>(3)</sup>	–	GV4P115	65...115	LC1D115/F115
55	97	100	–	–	–	<sup>(3)</sup>	<sup>(3)</sup>	<sup>(3)</sup>	–	–	–	–
75	132	70	75	125	65	–	–	–	–	GV5P150H	70...150	LC1D150
–	–	–	90	146	65	–	–	–	–	–	–	–
90	160	70	110	178	65	–	–	–	–	GV5P220H	100...220	LC1F225
110	195	70	–	–	–	–	–	–	–	GV5P220H	100...220	LC1F225
132	230	70	160	256	65	–	–	–	–	GV6P320H	160...320	LC1F265
160	280	70	200	318	65	–	–	–	–	GV6P320H	160...320	LC1F330
220	385	70	250	450	65	–	–	–	–	GV6P500H	250...500	LC1F500
250	450	70	300	473	65	–	–	–	–	–	–	–

(1) The breaking performance of circuit breakers GV2P can be increased by adding a current limiter GV1L3.

(2) Combinations with circuit breaker GV2ME are type 2 co or dinated only at 400/415 V and 440 V.

(3) Please consult your regional sales office.

#### ½ to 80 hp at 460 V - 3P

GV2P + contactor: compact, high SCCR solution.

GV3P + contactor: medium power, Everlink (long lasting power connection).

GV4PB + contactor: high power, advanced protection settings, Everlink (long lasting power connection), 18 (GV4PB●●●B), 35 (GV4PB●●●N) or 65 (GV4PB●●●S) kA SCCR.

Standard power ratings						Circuit breaker			Contactor		Circuit breaker			Contactor			
200 V 3P		230 V 3P		460 V 3P		Product reference	Dial range	Product reference	Comb. SCCR 480Y	Product reference	Dial range	Product reference	Comb. SCCR 480Y	Product reference	Dial range	Product reference	SCCR 480Y As applied
HP	FLA	HP	FLA	HP	FLA	(2)		(3)	(4)	(3)		(3)	(4)		(3)		
						A				A		kA		A		kA	
½	1.1			½	1.1	GV2P06	1 to 1.6	LC1D09	100			GV4PB02S	0.8 to 2	LC1D09		65	
		¾	1.6			GV2P06	1 to 1.6	LC1D09	100			GV4PB02S	0.8 to 2	LC1D09		65	
½	2.5	½	2.2	1	2.1	GV2P07	1.6 to 2.5	LC1D09	100			GV4PB03S	1.4 to 3.5	LC1D09		65	
				1½	3	GV2P08	2.5 to 4	LC1D09	100			GV4PB03S	1.4 to 3.5	LC1D09		65	
¾	3.7	¾	3.2	2	3.4	GV2P08	2.5 to 4	LC1D09	100			GV4PB07S	2.9 to 7	LC1D09		65	
1	4.6	1	4.2	3	4.8	GV2P10	4 to 6.3	LC1D09	100			GV4PB07S	2.9 to 7	LC1D09		65	
				1½	6	GV2P10	4 to 6.3	LC1D09	100			GV4PB12S	5 to 12.5	LC1D12		65	
1½	6.9	2	6.8			GV2P14	6 to 10	LC1D12	100			GV4PB12S	5 to 12.5	LC1D12		65	
2	7.8			5	7.6	GV2P14	6 to 10	LC1D12	100			GV4PB12S	5 to 12.5	LC1D12		65	
		3	9.6			GV2P14	6 to 10	LC1D12	100	GV3P13	9 to 13	LC1D18	65	GV4PB12S	5 to 12.5	LC1D12	65
3	11			7½	11	GV2P16	9 to 14	LC1D18	50 <sup>(5)</sup>	GV3P13	9 to 13	LC1D18	65	GV4PB25S	10 to 25	LC1D25	65
				10	14	GV2P16	9 to 14	LC1D18	50 <sup>(5)</sup>	GV3P18	12 to 18	LC1D18	65	GV4PB25S	10 to 25	LC1D25	65
5	17.5	5	15.2			GV2P20	13 to 18	LC1D18	50 <sup>(5)</sup>	GV3P18	12 to 18	LC1D18	65	GV4PB25S	10 to 25	LC1D25	65
		7½	22	15	21	GV2P21	17 to 23	LC1D25	50 <sup>(5)</sup>	GV3G25	17 to 25	LC1D25	65	GV4PB25S	10 to 25	LC1D25	65
7½	25.3					GV2P22	20 to 25	LC1D25	50 <sup>(5)</sup>	GV3P32	23 to 32	LC1D32	65	GV4PB50S	20 to 50	LC1D50A	65
		10	28	20	27					GV3P32	23 to 32	LC1D32	65	GV4PB50S	20 to 50	LC1D50A	65
10	32.2			25	34					GV3P40	30 to 40	LC1D40A	65	GV4PB50S	20 to 50	LC1D50A	65
		15	42	30	40					GV3P50	37 to 50	LC1D50A	65	GV4PB50S	20 to 50	LC1D50A	65
15	48									GV3P65	48 to 65	LC1D65A	65	GV4PB50S	20 to 50	LC1D50A	65
		20	54	40	52					GV3P65	48 to 65	LC1D65A	65	GV4PB80S	40 to 80	LC1D80	65
20	62.1													GV4PB115S	40 to 80	LC1D80	65
25	78.2	25	68	50	65									GV4PB115S	40 to 80	LC1D80	65
30	92	30	80	60	77									GV4PB115S	65 to 115	LC1D115	65

(1) Motor Full Load Amp Sizes are based on NEC Table 430.250.

(2) Requires use of GV1G09 or GV2GH7 line spacer for Type F rating.

(3) Add coil suffix to complete reference part number. For example, an LC1D09G7 includes a 120 V AC coil.

(4) Requires use of GV3G66 line spacer and GVAM11 short-circuit signaling contact for Type F rating.

(5) SCCR is 42 kA at 480Y when using GV2G busbar links.

0.06 to 250 kW at 400/415 V: type 1 coordination														
Standard power ratings of 3-phase motors 50/60 Hz in category AC-3									Circuit breaker			Contactor	Thermal overload relay	
400/415 V			440 V			500 V			Reference	Rating	I <sub>rm</sub> <sup>(1)</sup>	Reference <sup>(2)</sup>	Reference	Setting range
P	I <sub>e</sub>	I <sub>q</sub>	P	I <sub>e</sub>	I <sub>q</sub>	P	I <sub>e</sub>	I <sub>q</sub>		A	A			A
kW	A	kA	kW	A	kA	kW	A	kA						
0.06	0.2	50	0.06	0.19	50	–	–	–	GV2LE03	0.4	5	LC1K06	LR2K0302	0.16...0.23
–	–	–	0.09	0.28	50	–	–	–	GV2LE03	0.4	5	LC1K06	LR2K0303	0.23...0.36
0.09	0.3	50	0.12	0.37	50	–	–	–	GV2LE03	0.4	5	LC1K06	LR2K0304	0.36...0.54
0.12	0.44	50	–	–	–	–	–	–	GV2LE04	0.63	8	LC1K06	LR2K0304	0.36...0.54
0.18	0.6	50	0.18	0.55	50	–	–	–	GV2LE04	0.63	8	LC1K06	LR2K0305	0.54...0.8
–	–	–	0.25	0.76	50	–	–	–	GV2LE05	1	13	LC1K06	LR2K0305	0.54...0.8
0.25	0.85	50	–	–	–	–	–	–	GV2LE05	1	13	LC1K06	LR2K0306	0.8...1.2
0.37	1.1	50	0.37	1	50	0.37	0.88	50	–	–	–	–	–	–
0.55	1.5	50	0.55	1.36	50	0.55	1.2	50	GV2LE06	1.6	22.5	LC1K06	LR2K0307	1.2...1.8
–	–	–	–	–	–	0.75	1.5	50	–	–	–	–	–	–
–	–	–	0.75	1.68	50	–	–	–	GV2LE07	2.5	33.5	LC1K06	LR2K0307	1.2...1.8
0.75	1.9	50	–	–	–	–	–	–	GV2LE07	2.5	33.5	LC1K06	LR2K0308	1.8...2.6
1.1	2.7	50	1.1	2.37	50	1.1	2.2	50	–	–	–	–	–	–
1.5	3.6	50	1.5	3.06	50	1.5	2.9	50	GV2LE08	4	51	LC1K06	LR2K0310	2.6...3.7
–	–	–	–	–	–	2.2	3.9	50	GV2LE08	4	51	LC1K06	LR2K0312	3.7...5.5
2.2	4.9	50	2.2	4.4	50	3	5.2	50	GV2LE10	6.3	78	LC1K06	LR2K0312	3.7...5.5
–	–	–	3	5.77	50	–	–	–	GV2LE10	6.3	78	LC1K06	LR2K0314	5.5...8
–	–	–	4	7.9	15	–	–	–	GV2LE14	10	138	LC1K09	LR2K0314	5.5...8
3	6.5	50	–	–	–	4	6.8	10	GV2LE14	10	138	LC1K09	LR2K0314	5.5...8
4	8.5	50	–	–	–	–	–	–	GV2LE14	10	138	LC1K09	LR2K0316	8...11.5
5.5	11.5	15	5.5	10.4	8	7.5	12.4	6	GV2LE16	14	170	LC1K12	LR2K0321	10...14
–	–	–	7.5	13.7	8	9	13.9	6	GV2LE16	14	170	LC1D18	LRD21	12...18
7.5	15.5	15	9	16.9	8	–	–	–	GV2LE20	18	223	LC1D18	LRD21	12...18
9	18.1	15	–	–	–	11	17.6	4	GV2LE22	25	327	LC1D25	LRD22	16...24
11	22	15	11	20.1	6	15	23	4	GV2LE22	25	327	LC1D25	LRD22	16...24
15	29	10	15	26.5	6	18.5	28	4	GV2LE32	32	416	LC1D32	LRD32	23...32
18.5	35	50	18.5	32.5	50	22	33	10	GV3L40	40	560	LC1D40A	LRD340	30...40
22	41	50	22	39	50	30	44	10	GV3L50	50	700	LC1D50A	LRD350	37...50

(1) I<sub>rm</sub>: setting current of the magnetic trip.

(2) For reversing operation, replace the prefix LC1 with LC2.

0.06 to 250 kW at 400/415 V: type 1 coordination														
Standard power ratings of 3-phase motors 50/60 Hz in category AC-3									Circuit breaker			Contactor	Thermal overload relay	
400/415 V			440 V			500 V			Reference	Rating I <sub>rm</sub> <sup>(1)</sup>		Reference <sup>(2)</sup>	Reference	Setting range
P	I <sub>e</sub>	I <sub>q</sub>	P	I <sub>e</sub>	I <sub>q</sub>	P	I <sub>e</sub>	I <sub>q</sub>		A	A			A
kW	A	kA	kW	A	kA	kW	A	kA						
30	55	50	30	51.5	50	37	53	10	GV3L65	65	910	LC1D65A	LRD365	48...65
-	-	-	37	64	50	37	53	10	GV3L65	65	910	LC1D65A	LRD365	48...65
-	-	-	-	-	-	45	64	50	GV3L65	65	910	LC1D80	LRD3361	48...65
37	66	50	-	-	-	-	-	-	GV3L73	73	1120	LC1D80A	LRD380	62...80
-	-	-	37	64	70	-	-	-	GV4L80	80	880	LC1D65A	LRD365	48...65
-	-	-	-	-	-	45	64	30	GV4L80	80	880	LC1D80	LRD3361	48...65
37	66	100	-	-	-	-	-	-	GV4L80	80	1040	LC1D80	LRD3361	48...65
-	-	-	45	76	70	55	78	30	GV4L80	80	1040	LC1D80	LRD3363	63...80
45	80	100	-	-	-	-	-	-	GV4L115	115	1380	LC1D95	LRD3365	80...104
-	-	-	-	-	-	75	106	30	GV4L115	115	1380	LC1D115	LRD4367	95...120
-	-	-	55	90	70	-	-	-	GV4L115	115	1380	LC1D115	LRD4365	80...104
55	97	100	-	-	-	-	-	-	GV4L115	115	1495	LC1D115	LRD4367	95...120
-	-	-	-	-	-	50	90	<sup>(3)</sup>	NSX100●MA <sup>(3)</sup>	100	1200	LC1D115	LRD4365	80...104
-	-	-	-	-	-	75	106	<sup>(3)</sup>	NSX160●MA <sup>(3)</sup>	150	1500	LC1D115	LRD4367	95...120
55	97	<sup>(3)</sup>	-	-	-	-	-	-	NSX160●MA <sup>(3)</sup>	150	1350	LC1D115	LRD4367	95...120
75	132	<sup>(3)</sup>	75	125	<sup>(3)</sup>	90	128	<sup>(3)</sup>	NSX160●MA <sup>(3)</sup>	150	1800	LC1D150	LRD4369	110...140
-	-	-	90	146	<sup>(3)</sup>	-	-	-	NSX160●MA <sup>(3)</sup>	150	1950	LC1F185	LR9F5371	132...220
90	160	<sup>(3)</sup>	-	-	-	110	156	<sup>(3)</sup>	NSX250●MA <sup>(3)</sup>	220	2200	LC1F185	LR9F5371	132...220
110	195	<sup>(3)</sup>	-	-	-	-	-	-	NSX250●MA <sup>(3)</sup>	220	2640	LC1F225	LR9F5371	132...220
-	-	-	110	178	<sup>(3)</sup>	-	-	-	NSX250●MA <sup>(3)</sup>	220	2420	LC1F225	LR9F5371	132...220
-	-	-	-	-	-	132	184	<sup>(3)</sup>	NSX250●MA <sup>(3)</sup>	220	2640	LC1F265	LR9F5371	132...220
-	-	-	132	215	<sup>(3)</sup>	-	-	-	NSX250●MA <sup>(3)</sup>	220	2860	LC1F265	LR9F5371	132...220
132	230	<sup>(3)</sup>	-	-	-	-	-	-	NSX400● + Micrologic 1.3M <sup>(3)</sup>	320	3200	LC1F265	LR9F7375	200...330
-	-	-	-	-	-	160	224	<sup>(3)</sup>	NSX400● + Micrologic 1.3M <sup>(3)</sup>	320	2860	LC1F265	LR9F7375	200...330
-	-	-	160	256	<sup>(3)</sup>	-	-	-	NSX400● + Micrologic 1.3M <sup>(3)</sup>	320	3520	LC1F330	LR9F7375	200...330
160	280	<sup>(3)</sup>	200	321	<sup>(3)</sup>	-	-	-	NSX400● + Micrologic 1.3M <sup>(3)</sup>	320	4160	LC1F330	LR9F7375	200...330
-	-	-	-	-	-	200	280	<sup>(3)</sup>	NSX400● + Micrologic 1.3M <sup>(3)</sup>	320	3840	LC1F330	LR9F7375	200...330
-	-	-	-	-	-	220	310	<sup>(3)</sup>	NSX400● + Micrologic 1.3M <sup>(3)</sup>	320	4160	LC1F400	LR9F7379	300...500
200	350	<sup>(3)</sup>	220	353	<sup>(3)</sup>	-	-	-	NSX400● + Micrologic 1.3M <sup>(3)</sup>	500	5000	LC1F400	LR9F7379	300...500
-	-	-	250	401	<sup>(3)</sup>	-	-	-	NSX630● + Micrologic 1.3M <sup>(3)</sup>	500	5550	LC1F400	LR9F7379	300...500
-	-	-	-	-	-	250	344	<sup>(3)</sup>	NSX630● + Micrologic 1.3M <sup>(3)</sup>	500	5000	LC1F400	LR9F7379	300...500
220	388	<sup>(3)</sup>	-	-	-	-	-	-	NSX630● + Micrologic 1.3M <sup>(3)</sup>	500	5500	LC1F400	LR9F7379	300...500
250	430	<sup>(3)</sup>	280	470	<sup>(3)</sup>	315	432	<sup>(3)</sup>	NSX630● + Micrologic 1.3M <sup>(3)</sup>	500	6000	LC1F500	LR9F7379	300...500
-	-	-	-	-	-	355	488	<sup>(3)</sup>	NSX630● + Micrologic 1.3M <sup>(3)</sup>	500	6500	LC1F500	LR9F7381	380...630

(1) I<sub>rm</sub>: setting current of the magnetic trip.

(2) For reversing operation, replace the prefix LC1 with LC2.

(3) Reference to be completed by replacing the ● with the breaking performance code:

Breaking performance I <sub>q</sub> (kA)	NSX100●MA		NSX160●MA and NSX250●MA		NSX400● and NSX630●
400/415 V	36	70	36	70	70 150
440 V	35	65	35	65	65 130
500 V	25	50	25	50	50 70
660/690 V	8	10	8	10	20 20
Code	F	H	F	H	H L

0.06 to 250 kW at 400/415 V: type 2 coordination														
Standard power ratings of 3-phase motors 50/60 Hz in category AC-3									Circuit breaker			Contactor	Thermal overload relay	
400/415 V			440 V			500 V			Reference	Rating	I <sub>rm</sub> <sup>(1)</sup>	Reference <sup>(2)</sup>	Reference	Setting range
P	I <sub>e</sub>	I <sub>q</sub>	P	I <sub>e</sub>	I <sub>q</sub>	P	I <sub>e</sub>	I <sub>q</sub>						
kW	A	kA	kW	A	kA	kW	A	kA	A	A	A	A	A	
0.06	0.2	130	0.06	0.19	130	-	-	-	GV2L03 or LE03	0.4	5	LC1D09	LRD02	0.16...0.25
0.09	0.3	130	0.09	0.28	130	-	-	-	GV2L03 or LE03	0.4	5	LC1D09	LRD03	0.25...0.40
-	-	-	0.12	0.37	130	-	-	-						
0.12	0.44	130	-	-	-	-	-	-	GV2L04 or LE04	0.63	8	LC1D09	LRD04	0.4...0.63
0.18	0.6	130	0.18	0.55	130	-	-	-						
0.25	0.85	130	0.25	0.76	130	-	-	-	GV2L05 or LE05	1	13	LC1D09	LRD05	0.63...1
0.37	1.1	130	0.37	0.99	130	-	-	-						
-	-	-	-	-	-	0.37	0.88	130	GV2L05 or LE05	1	13	LC1D09	LRD06	1...1.7
0.55	1.5	130	-	-	-	0.55	1.2	130	GV2L06 or LE06	1.6	22.5	LC1D09	LRD06	1...1.7
-	-	-	0.55	1.36	130	0.75	1.5	130						
0.75	1.9	130	0.75	1.68	130	1.1	2.2	130	GV2L07 or LE07	2.5	33.5	LC1D09	LRD07	1.6...2.5
1.1	2.7	130	1.1	2.37	130	1.5	2.9	130	GV2L08 or LE08	4	51	LC1D09	LRD08	2.5...4
1.5	3.6	130	-	-	-	2.2	3.9	130						
-	-	-	1.5	3.06	130	-	-	-	GV2L08 or LE08	4	51	LC1D09	LRD10	4...6
2.2	4.9	130	-	-	-	-	-	-	GV2L10 or LE10	6.3	78	LC1D09	LRD10	4...6
-	-	-	-	-	-	3	5.2	13						
-	-	-	2.2	4.42	50	-	-	-	GV2LE10	6.3	78	LC1D09	LRD10	4...6
-	-	-	3	5.77	50	3	5.2	50						
-	-	-	2.2	4.42	130	-	-	-	GV2L10	6.3	78	LC1D09	LRD10	4...6
-	-	-	3	5.77	130	3	5.2	130						
3	6.5	130	-	-	-	-	-	-	GV2L14 or LE14	10	10	LC1D09	LRD12	5.5...8
-	-	-	-	-	-	4	6.8	10	GV2LE14	10	138	LC1D12	LRD12	5.5...8
-	-	-	-	-	-	4	6.8	50	GV2L14	10	138	LC1D12	LRD12	5.5...8
4	8.5	130	-	-	-	-	-	-	GV2L14 or LE14	10	138	LC1D09	LRD14	7...10
-	-	-	4	7.9	15	-	-	-	GV2LE14	10	138	LC1D09	LRD14	7...10
-	-	-	4	7.9	130	-	-	-	GV2L14	10	138	LC1D09	LRD14	7...10
-	-	-	-	-	-	5.5	9.2	10	GV2LE14	10	138	LC1D09	LRD14	7...10
-	-	-	-	-	-	5.5	9.2	50	GV2L14	10	138	LC1D09	LRD14	7...10
5.5	11.5	130	5.5	10.4	50	7.5	12.4	42	GV2L16	14	170	LC1D25	LRD16	9...13
-	-	-	7.5	13.7	50	-	-	-	GV2L16	14	170	LC1D25	LRD21	12...18
7.5	15.5	50	9	16.9	20	9	13.9	10	GV2L20	18	223	LC1D25	LRD21	12...18
9	18.1	50	-	-	-	-	-	-	GV2L22	25	327	LC1D25	LRD22	16...24
11	22	50	11	20.1	20	-	-	-						
-	-	-	-	-	-	11	17.6	10	GV2L22	25	327	LC1D32	LRD22	16...24
-	-	-	-	-	-	15	23	10						
15	29	50	15	26.5	50	-	-	-	GV3L32	32	448	LC1D40A	LRD332	23...32
-	-	-	-	-	-	18.5	28	10	GV3L32	32	448	LC1D65A	LRD332	23...32

(1) I<sub>rm</sub>: setting current of the magnetic trip.

(2) For reversing operation, replace the prefix LC1 with LC2.



#### 0.06 to 250 kW at 400/415 V: type 2 coordination

Standard power ratings of 3-phase motors 50/60 Hz in category AC-3									Circuit breaker			Contactor	Thermal overload relay	
400/415 V			440 V			500 V			Reference	Rating	I <sub>rm</sub> <sup>(1)</sup>	Reference <sup>(2)</sup>	Reference	Setting range
P	I <sub>e</sub>	I <sub>q</sub>	P	I <sub>e</sub>	I <sub>q</sub>	P	I <sub>e</sub>	I <sub>q</sub>		A	A			A
kW	A	kA	kW	A	kA	kW	A	kA						
18.5	35	50	–	–	–	–	–	–	GV3L40	40	560	LC1D50A	LRD340	30...40
–	–	–	18.5	32.5	50	–	–	–	GV3L40	40	560	LC1D65A	LRD340	30...40
22	41	50	–	–	–	–	–	–	GV3L50	50	700	LC1D50A	LRD350	37...50
–	–	–	22	39	50	30	44	10	GV3L50	50	700	LC1D65A	LRD350	37...50
30	55	50	30	51.5	50	37	53	10	GV3L65	65	910	LC1D65A	LRD365	48...65
37	66	50	–	–	–	–	–	–	GV3L73	73	1120	LC1D80A	LRD380	62...80
45	60	50	–	–	–	–	–	–	GV3L80	80	1120	LC1D95	LRD3363	63...80
–	–	–	37	64	70	–	–	–	GV4L80	80	880	LC1D65A	LRD365	48...65
37	66	100	45	76	70	<sup>(4)</sup>	<sup>(4)</sup>	<sup>(4)</sup>	GV4L80	80	1040	LC1D80	LRD3363	63...80
45	80	100	55	90	70	<sup>(4)</sup>	<sup>(4)</sup>	<sup>(4)</sup>	GV4L115	115	1380	LC1D115 LC1F115	LR9D5367 LR9F5367	60...100 60...100
55	97	100	–	–	–	<sup>(4)</sup>	<sup>(4)</sup>	<sup>(4)</sup>	GV4L115	115	1495	LC1D115 LC1F115	LR9D5369 LR9F5369	90...150 90...150
–	–	–	–	–	–	55	78	<sup>(3)</sup>	NSX100●MA <sup>(3)</sup>	100	1040	LC1D80	LRD3363	63...80
45	80	<sup>(3)</sup>	55	90	<sup>(3)</sup>	–	–	–	NSX100●MA <sup>(3)</sup>	100	1300	LC1D115	LR9D5367	60...100
55	97	<sup>(3)</sup>	–	–	–	–	–	–	NSX160●MA <sup>(3)</sup>	150	1500	LC1D115	LR9D5369	90...150
–	–	–	–	–	–	75	106	<sup>(3)</sup>	NSX160●MA <sup>(3)</sup>	150	1950	LC1D115	LR9D5369	90...150
75	132	<sup>(3)</sup>	75	125	<sup>(3)</sup>	–	–	–	NSX160●MA <sup>(3)</sup>	150	1950	LC1D150	LR9D5369	90...150
–	–	–	90	146	<sup>(3)</sup>	–	–	–	NSX160●MA <sup>(3)</sup>	150	1950	LC1D150	LR9D5369	90...150
–	–	–	–	–	–	90	128	<sup>(3)</sup>	NSX160●MA <sup>(3)</sup>	150	1200	LC1D150	LR9D5369	90...150
90	160	<sup>(3)</sup>	110	178	<sup>(3)</sup>	–	–	–	NSX250●MA <sup>(3)</sup>	220	2420	LC1F185	LR9F5371	132...220
–	–	–	–	–	–	110	156	<sup>(3)</sup>	NSX250●MA <sup>(3)</sup>	220	1540	LC1F185	LR9F5371	132...220
110	195	<sup>(3)</sup>	–	–	–	–	–	–	NSX250●MA <sup>(3)</sup>	220	2860	LC1F225	LR9F5371	132...220
–	–	–	132	215	<sup>(3)</sup>	132	184	<sup>(3)</sup>	NSX400● + Micrologic 1.3M <sup>(3)</sup>	320	3500	LC1F265	LR9F5371	132...220
132	230	<sup>(3)</sup>	160	256	<sup>(3)</sup>	–	–	–	NSX400● + Micrologic 1.3M <sup>(3)</sup>	320	3520	LC1F265	LR9F7375	200...330
–	–	–	–	–	–	160	224	<sup>(3)</sup>	NSX400● + Micrologic 1.3M <sup>(3)</sup>	320	2200	LC1F265	LR9F7375	200...330
160	280	<sup>(3)</sup>	–	–	–	–	–	–	NSX400● + Micrologic 1.3M <sup>(3)</sup>	320	4000	LC1F330	LR9F7375	200...330
–	–	–	200	321	<sup>(3)</sup>	–	–	–	NSX400● + Micrologic 1.3M <sup>(3)</sup>	320	4000	LC1F330	LR9F7379	300...500
–	–	–	–	–	–	200	280	<sup>(3)</sup>	NSX400● + Micrologic 1.3M <sup>(3)</sup>	320	3500	LC1F400	LR9F7375	200...330
–	–	–	–	–	–	220	310	<sup>(3)</sup>	NSX400● + Micrologic 1.3M <sup>(3)</sup>	320	3500	LC1F400	LR9F7379	300...500
–	–	–	220	353	<sup>(3)</sup>	–	–	–	NSX630● + Micrologic 1.3M <sup>(3)</sup>	500	5500	LC1F400	LR9F7379	300...500
200	350	<sup>(3)</sup>	250	401	<sup>(3)</sup>	–	–	–	NSX630● + Micrologic 1.3M <sup>(3)</sup>	500	4500	LC1F500	LR9F7379	300...500
–	–	–	–	–	–	250	344	<sup>(3)</sup>	NSX630● + Micrologic 1.3M <sup>(3)</sup>	500	4500	LC1F500	LR9F7379	300...500
220	388	<sup>(3)</sup>	–	–	–	–	–	–	NSX630● + Micrologic 1.3M <sup>(3)</sup>	500	6250	LC1F500	LR9F7379	300...500
250	430	<sup>(3)</sup>	–	–	–	–	–	–	NSX630● + Micrologic 1.3M <sup>(3)</sup>	500	6250	LC1F500	LR9F7379	300...500
–	–	–	–	–	–	355	488	<sup>(3)</sup>	NSX630● + Micrologic 1.3M <sup>(3)</sup>	500	5000	LC1F630	LR9F7381	380...630

(1) I<sub>rm</sub>: setting current of the magnetic trip.

(2) For reversing operation, replace the prefix LC1 with LC2.

(3) Reference to be completed by replacing the ● with the breaking performance code:

Breaking performance I <sub>q</sub> (kA)	NSX100●MA	NSX160●MA and NSX250●MA	NSX400● and NSX630●
400/415 V	36	70	150
440 V	35	65	130
500 V	25	50	70
660/690 V	8	10	20
Code	F	H	L

(4) Please consult your regional sales office.



0.06 to 30 kW at 400/415 V: type 2 coordination												
Standard power ratings of 3-phase motors 50/60 Hz in category AC-3						Circuit breaker			Contactor		Electronic thermal overload relay	
400/415 V			690 V			Reference	Rating	I <sub>rm</sub>	Reference	Reference	Setting range	
P	I <sub>e</sub>	I <sub>q</sub>	P	I <sub>e</sub>	I <sub>q</sub>		A	A			A	
kW	A	kA	kW	A	kA							
0.06	0.2	100	–	–	–	GV2L03	0.4	5	LC1D09	LR9D01	0.1...0.5	
0.09	0.3	100	–	–	–	GV2L03	0.4	5	LC1D09	LR9D01	0.1...0.5	
0.12	0.44	100	–	–	–	GV2L04	0.63	8	LC1D18	LR9D02	0.4...2.0	
0.18	0.6	100	–	–	–	GV2L04	0.63	8	LC1D18	LR9D02	0.4...2.0	
0.25	0.85	100	–	–	–	GV2L05	1	13	LC1D18	LR9D02	0.4...2.0	
0.37	1.1	100	–	–	–	GV2L05	1	13	LC1D18	LR9D02	0.4...2.0	
0.55	1.5	100	–	–	–	GV2L06	1.6	22.5	LC1D18	LR9D02	0.4...2.0	
0.75	1.9	100	–	–	–	GV2L07	2.5	33.5	LC1D18	LR9D08	1.6...8.0	
1.1	2.7	100	–	–	–	GV2L08	4	51	LC1D18	LR9D08	1.6...8.0	
1.5	3.6	100	–	–	–	GV2L08	4	51	LC1D18	LR9D08	1.6...8.0	
2.2	4.9	100	–	–	–	GV2L10	6.3	78	LC1D18	LR9D08	1.6...8.0	
3	6.5	100	–	–	–	GV2L14	10	138	LC1D25	LR9D32	6.4...32	
4	8.5	100	–	–	–	GV2L14	10	138	LC1D25	LR9D32	6.4...32	
5.5	11.5	100	–	–	–	GV2L16	14	170	LC1D25	LR9D32	6.4...32	
7.5	15.5	50	–	–	–	GV2L20	18	223	LC1D25	LR9D32	6.4...32	
11	22	50	–	–	–	GV2L22	25	327	LC1D25	LR9D32	6.4...32	
15	29	50	–	–	–	GV3L32	40	448	LC1D65A	LR9D110S	22...110	
18.5	35	50	–	–	–	GV3L40	40	560	LC1D65A	LR9D110S	22...110	
22	41	50	–	–	–	GV3L50	50	700	LC1D65A	LR9D110S	22...110	
30	55	50	–	–	–	GV3L65	65	910	LC1D65A	LR9D110S	22...110	
–	–	–	0.37	0.64	50	GV2L05	1	13	LC1D09	LR9D02	0.4...2.0	
–	–	–	0.55	0.87	50	GV2L05	1	13	LC1D09	LR9D02	0.4...2.0	
–	–	–	0.75	1.1	50	GV2L06	1.6	22.5	LC1D09	LR9D02	0.4...2.0	
–	–	–	1.1	1.6	50	GV2L07 + LA9LB920	2.5	33.5	LC1D25	LR9D08	1.6...8.0	
–	–	–	1.5	2.1	50	GV2L07 + LA9LB920	2.5	33.5	LC1D25	LR9D08	1.6...8.0	
–	–	–	2.2	2.8	50	GV2L08 + LA9LB920	4	51	LC1D25	LR9D08	1.6...8.0	
–	–	–	3	4	50	GV2L08 + LA9LB920	4	51	LC1D25	LR9D08	1.6...8.0	
–	–	–	4	5	50	GV2L10 + LA9LB920	6.3	78	LC1D25	LR9D08	1.6...8.0	
–	–	–	5.5	7	50	GV2L14 + LA9LB920	10	138	LC1D25	LR9D32	6.4...32	
–	–	–	7.5	8.9	50	GV2L14 + LA9LB920	10	138	LC1D25	LR9D32	6.4...32	
–	–	–	11	13	3	GV3L18+ LA9LB920	14	252	LC1D32	LR9D32	6.4...32	
–	–	–	15	16.5	3	GV2L22 + LA9LB920	18	327	LC1D32	LR9D32	6.4...32	
–	–	–	18.5	21	3	GV3L25 + LA9LB920	25	350	LC1D65A	LR9D32	6.4...32	
–	–	–	22	25	3	GV2L32 + LA9LB920	32	416	LC1D65A	LR9D32	6.4...32	

#### 1.5 to 315 kW at 400/415 V: type 1 coordination

**Maximum operating rate:** LC3K and LC3F: 12 starts/hour; LC3D: 30 starts/hour.

**Maximum starting time:** LC3K and LC3D: 30 seconds; LC3F: 20 seconds.

Standard power ratings of 3-phase motors 50/60 Hz in category AC-3								Fuse carrier (basic block)	aM fuses		Star-delta contactors	Thermal overload relay	
400/415 V				440 V				Reference	Size	Rating	Reference	Reference	Setting range
P	I <sub>e</sub>	I <sub>rD</sub> <sup>(1)</sup>	I <sub>q</sub>	P	I <sub>e</sub>	I <sub>rD</sub> <sup>(1)</sup>	I <sub>q</sub>						
kW	A	A	kA	kW	A	A	kA		A			A	
1.5	3.5	2	50	1.5	3.06	2	50	LS1D32	10 x 38	4	LC3K06	LR2K0308	1.8...2.6
2.2	5	3	50	-	-	-	-	LS1D32	10 x 38	6	LC3K06	LR2K0310	2.6...3.7
-	-	-	-	2.2	4.42	3	50						
-	-	-	-	3	5.77	3	50	LS1D32	10 x 38	8	LC3K06	LR2K0310	2.6...3.7
3	6.5	4	50	-	-	-	-	LS1D32	10 x 38	8	LC3K06	LR2K0312	3.7...5.5
4	8.4	5	50	4	7.9	5	50	LS1D32	10 x 38	12	LC3K06	LR2K0312	3.7...5.5
5.5	11	6	50	5.5	10.4	6	50	LS1D32	10 x 38	16	LC3K06	LR2K0314	5.5...8
7.5	14.8	9	50	7.5	13.7	8	50	LS1D32	10 x 38	16	LC3K09	LR2K0316	8...11.5
9	18.1	10	100	9	16.9	10	50	LS1D32	10 x 38	20	LC3D12A	LRD16	9...13
11	21	12	100	11	20.1	12	100	GK1EK	14 x 51	25	LC3D12A	LRD16	9...13
15	28.5	16	100	15	26.5	15	100	GK1EK	14 x 51	32	LC3D18A	LRD21	12...18
18.5	35	20	100	18.5	32.8	19	100	GK1EK	14 x 51	40	LC3D18A	LRD22	16...24
-	-	-	-	22	39	23	100	GS●J	22 x 58	50	LC3D18A	LRD22	16...24
22	42	24	100	-	-	-	-	GS●J	22 x 58	50	LC3D32A	LRD32	23...32
-	-	-	-	30	51.5	30	100	GS●J	22 x 58	63	LC3D32A	LRD32	23...32
30	57	33	100	37	64	37	100	GS●J	22 x 58	80	3 x LC1D40A	LRD340	30...40
37	69	40	100	-	-	-	-	GS●J	22 x 58	80	3 x LC1D40A	LRD350	37...50
-	-	-	-	45	76	44	100	GS●J	22 x 58	80	3 x LC1D50A	LRD350	37...50
45	81	47	100	-	-	-	-	GS●J	22 x 58	100	3 x LC1D50A	LRD350	37...50
-	-	-	-	55	90	52	100	GS●K	22 x 58	100	3 x LC1D50A	LRD365	48...65
55	100	58	100	-	-	-	-	GS●K	22 x 58	125	3 x LC1D65A	LRD365	48...65
75	135	78	100	75	125	72	100	GS●L	T0	160	LC3D80	LRD3363	63...80
-	-	-	-	90	146	84	100	GS●L	T0	160	LC3D115	LRD4365	80...104
90	165	95	100	-	-	-	-	GS●N	T1	200	LC3D115	LRD4367	95...120
110	200	115	100	110	178	103	100	GS●N	T1	200	LC3D115	LRD4367	95...120
132	240	139	100	132	215	124	100	GS●QQ	T2	250	LC3D150	LRD4369	110...140
160	285	165	100	160	256	148	100	GS●QQ	T2	315	LC3F185	LR9F5371	132...220
-	-	-	-	200	321	185	100	GS●QQ	T2	400	LC3F225	LR9F5369	132...220
220	388	225	100	-	-	-	-	GS●QQ	T2	400	LC3F265	LR9F7375	200...330
-	-	-	-	250	401	233	100	GS2S	T3	500	LC3F265	LR9F7375	200...330
280	480	278	100	-	-	-	-	GS2S	T3	500	LC3F330	LR9F7375	200...330
-	-	-	-	315	505	293	100						
315	555	322	100	355	518	300	100	GS2S	T3	630	LC3F330	LR9F7375	200...330
-	-	-	-	375	575	334	100	GS2S	T3	630	LC3F400	LR9F7379	300...500

(1) I<sub>rD</sub>: current in the motor windings in delta connection.

#### 1.5 to 355 kW at 400/415 V: type 2 coordination

**Maximum operating rate:** LC1D: 30 starts/hour; LC1F: 12 starts/hour.

**Maximum starting time:** LC1D: 30 seconds; LC1F: 20 seconds.

Standard power ratings of 3-phase motors 50/60 Hz in category AC-3						Switch-disconnector-fuse	aM fuses		Star-delta contactors	Thermal overload relay	
400/415 V			440 V				Reference	Size		Rating	Reference
P	le	Iq	P	le	Iq			A			A
kW	A	kA	kW	A	kA						
1.5	3.5	50	1.5	3.06	50	GS1DD	10 x 38	4	3 x LC1D09	LRD08	2.5...4
2.2	5	50	2.2	4.42	50	GS1DD	10 x 38	6	3 x LC1D09	LRD10	4...6
3	6.5	50	3	5.77	50	GS1DD	10 x 38	8	3 x LC1D09	LRD12	5.5...8
4	8.4	50	4	7.9	50	GS1DD	10 x 38	10	3 x LC1D09	LRD14	7...10
5.5	11	50	5.5	10.4	50	GS1DD	10 x 38	16	3 x LC1D12	LRD16	9...13
7.5	14.8	50	7.5	13.7	50	GS1DD	10 x 38	16	3 x LC1D18	LRD21	12...18
9	18.1	100	9	16.9	100						
11	21	100	11	20.1	100	GS•F	14 x 51	25	3 x LC1D25	LRD22	16...24
15	28.5	100	15	26.5	100	GS•F	14 x 51	32	3 x LC1D32	LRD32	23...32
18.5	35	100	18.5	32.8	100	GS•F	14 x 51	40	3 x LC1D40A	LRD340	30...40
22	42	100	22	39	100	GS•J	22 x 58	50	3 x LC1D50A	LRD350	37...50
30	57	100	30	51.5	100	GS•J	22 x 58	80	3 x LC1D65A	LRD365	48...65
37	69	100	37	64	100	GS•J	22 x 58	80	3 x LC1D80	LRD3363	63...80
–	–	–	45	76	100	GS•J	22 x 58	80	3 x LC1D80	LRD3365	80...93
45	81	100	–	–	–	GS•J	22 x 58	100	3 x LC1D115	LR9D5367	60...100
–	–	–	55	90	100	GS•L	T0	125	3 x LC1D115	LR9D5369	90...150
55	100	100	–	–	–	GS•L	T0	125	3 x LC1D150	LR9D5369	90...150
–	–	–	75	125	100	GS•L	T0	160	3 x LC1D150	LR9D5369	90...150
75	135	100	–	–	–	GS•L	T0	160	3 x LC1F185	LR9D5369	90...150
90	165	100	90	146	100	GS•N	T1	200	3 x LC1F185	LR9F5371	132...220
110	200	100	110	178	100	GS•N	T1	250	3 x LC1F225	LR9F5371	132...220
132	240	100	132	215	100	GS•QQ	T2	315	3 x LC1F265	LR9F7375	200...330
160	285	100	160	256	100	GS•QQ	T2	400	3 x LC1F330	LR9F7375	200...330
–	–	–	200	321	100	GS•QQ	T2	400	3 x LC1F330	LR9F7379	300...500
200	352	100	220	353	100						
220	388	100	250	401	100	GS2S	T3	500	3 x LC1F400	LR9F7379	300...500
250	437	100	–	–	–	GS2S	T3	500	3 x LC1F500	LR9F7379	300...500
315	555	100	315	505	100	GS2S	T3	630	3 x LC1F630	LR9F7381	380...630
–	–	–	355	549	100						
–	–	–	400	611	100	GS2V	T4	800	3 x LC1F630	LR9F7381	380...630
355	605	100	–	–	–	GS2V	T4	800	3 x LC1F780	LR9F7381	380...630

#### 1.5 to 375 kW at 415 V: type 2 coordination

Maximum operating rate: LC1D: 30 starts/hour; LC1F: 12 starts/hour.

Maximum starting time: LC1D: 30 seconds; LC1F: 20 seconds.

Standard power ratings of 3-phase motors 50/60 Hz in category AC-3						Switch-disconnector-fuse	BS fuses		Star-delta contactors	Thermal overload relay	
415 V			440 V				Reference	Size	Rating	Reference	Reference
P	I <sub>e</sub>	I <sub>q</sub>	P	I <sub>e</sub>	I <sub>q</sub>			A			A
kW	A	kA	kW	A	kA						
1.5	3.5	50	1.5	3.06	50	GS1DDB	A1	NIT 16	3 x LC1D09	LRD08	2.5...4
2.2	5	50	2.2	4.42	50	GS1DDB	A1	NIT 16	3 x LC1D09	LRD10	4...6
3	6.5	50	3	5.77	50	GS1DDB	A1	NIT 20	3 x LC1D09	LRD12	5.5...8
4	8.4	50	4	7.9	50	GS1DDB	A1	NIT 20	3 x LC1D09	LRD14	7...10
5.5	11	50	5.5	10.4	50	GS1DDB	A1	NIT 20M25	3 x LC1D12	LRD16	9...13
7.5	14.8	50	7.5	13.7	50	GS1DDB	A1	NIT 20M32	3 x LC1D18	LRD21	12...18
9	18.1	50	9	16.9	50	GS2GB	A2	TIA 32M35	3 x LC1D18	LRD21	12...18
11	21	50	11	20.1	50	GS2GB	A2	TIA 32M50	3 x LC1D25	LRD22	16...24
15	28.5	50	15	26.5	50	GS2GB	A2	TIA 32M63	3 x LC1D32	LRD32	23...32
22	42	50	22	39	50	GS2GB	A3	TIS 63M80	3 x LC1D50A	LRD350	37...50
-	-	-	30	51.5	50	GS2GB	A3	TIS 63M100	3 x LC1D65A	LRD365	48...65
30	57	50	-	-	-	GS2GB	A3	TIS 63M100	3 x LC1D65A	LRD365	48...65
45	81	50	45	76	50	GS2LLB	A4	TCP 100M125	3 x LC1D80	LRD3363	63...80
55	100	80	55	90	80	GS2LLB	A4	TCP 100M160	3 x LC1D115	LR9D5369	90...150
80	138	80	80	132	80	GS2LB	B2	TF 200M250	3 x LC1D150	LR9D5369	90...150
100	182	80	100	162	80	GS2MMB	B2	TF 200M250	3 x LC1F185	LR9F5371	132...220
110	196	80	110	178	80	GS2MMB	B2	TF 200M315	3 x LC1F225	LR9F5371	132...220
140	250	80	140	226	80	GS2NB	B3	TFK 315M355	3 x LC1F265	LR9F7375	200...330
160	285	80	160	256	80	GS2QQB	B3	TFK 315M355	3 x LC1F330	LR9F7375	200...330
220	388	80	220	353	80	GS2QQB	B4	TMF 400M450	3 x LC1F400	LR9F7379	300...500
257	450	80	257	412	80	GS2SB	C2	TTM 500	3 x LC1F500	LR9F7379	300...500
270	460	80	270	433	80						
375	610	80	375	577	80	GS2SB	C2	TTM 630	3 x LC1F630	LR9F7381	380...630

Coordination and standards

#### 1.5 to 110 kW at 400/415 V: type 1 coordination

Maximum operating rate: LC3K: 12 starts/hour; LC3D: 30 starts/hour.

Maximum starting time: 30 seconds.

Standard power ratings of 3-phase motors 50-60 Hz in category AC-3								Circuit breaker		Star-delta contactors
400/415 V				440 V				Reference	Setting range of thermal trips	Reference
P	I <sub>e</sub>	I <sub>rD</sub> <sup>(1)</sup>	I <sub>q</sub> <sup>(2)</sup>	P	I <sub>e</sub>	I <sub>rD</sub> <sup>(1)</sup>	I <sub>q</sub> <sup>(2)</sup>	<i>References in italics are available in CEE zone only</i>		
kW	A	A	kA	kW	A	A	kA		A	
1.5	3.6	2	50	1.5	3.06	1.8	50	<b>GV2ME08</b> <i>GV2ME08AP</i>	2.5...4	<b>LC3K06</b>
2.2	4.9	2.9	50	2.2	4.42	2.6	50	<b>GV2ME10</b> <i>GV2ME10AP</i>	4...6.3	<b>LC3K06</b>
–	–	–	–	3	5.77	3.3	50			
3	6.5	3.8	50	–	–	–	–	<b>GV2ME14</b> <i>GV2ME14AP</i>	6...10	<b>LC3K06</b>
4	8.5	4.9	50	4	7.9	4.6	15			
5.5	11.5	6.4	15	5.5	10.4	6	8	<b>GV2ME16</b> <i>GV2ME16AP</i>	9...14	<b>LC3K06</b>
7.5	15.5	8.6	15	7.5	13.7	7.9	8	<b>GV2ME20</b> <i>GV2ME20AP</i>	13...18	<b>LC3K09</b>
–	–	–	–	9	16.9	9.8	8	<b>GV2ME20</b> <i>GV2ME20AP</i>	13...18	<b>LC3D12A</b>
9	18.1	10	15	11	20.1	12	6	<b>GV2ME21</b> <i>GV2ME21AP</i>	17...23	<b>LC3D12A</b>
11	22	12	15	–	–	–	–	<b>GV2ME22</b> <i>GV2ME22AP</i>	20...25	<b>LC3D12A</b>
15	29	17	10	15	26.5	15	6	<b>GV2ME32</b> <i>GV2ME32AP</i>	24...32	<b>LC3D18A</b>
18.5	35	20	50	18.5	32.8	19	50	<b>GV3P40</b>	30...40	<b>LC3D18A</b>
–	–	–	–	22	39	23	50	<b>GV3P50</b>	37...50	<b>LC3D32A</b>
22	41	24	50	30	51.5	30	50	<b>GV3P50</b>	37...50	<b>LC3D32A</b>
30	55	33	50	30	51.5	30	50	<b>GV3P65</b>	48...65	<b>LC3D32A</b>
37	66	40	50	37	64	37	50	<b>GV3P65</b>	48...65	3 x <b>LC1D40A</b> <sup>(3)</sup>
37	66	40	100	37	64	37	70	<b>GV4P80</b>	40...80	3 x <b>LC1D40A</b> <sup>(3)</sup>
–	–	–	–	45	76	44	70	<b>GV4P80</b>	40...80	2 x <b>LC1D50A</b> +1 x <b>LC1D40A</b> <sup>(3)</sup>
45	80	47	100	–	–	–	–	<b>GV4P115</b>	65...115	2 x <b>LC1D50A</b> +1 x <b>LC1D40A</b> <sup>(3)</sup>
55	97	58	100	55	90	52	70	<b>GV4P115</b>	65...115	2 x <b>LC1D65A</b> +1 x <b>LC1D40A</b> <sup>(3)</sup>
75	132	78	35	75	125	72	35	<b>GV5P150F</b>	70...150	<b>LC3D80</b>
–	–	–	–	90	146	84	35	<b>GV5P150F</b>	0...150	<b>LC3D115</b>
90	160	95	35	110	178	103	35	<b>GV5P220F</b>	100...220	<b>LC3D115</b>
110	195	115	35	–	–	–	–			
–	–	–	–	132	215	124	35	<b>GV5P220F</b>	100...220	<b>LC3D150</b>
132	230	135	36	–	–	–	–	<b>GV6P320F</b>	160...320	<b>LC3D150</b> or 3 x <b>LC1F150</b>
160	270	158	36	160	256	94	35	<b>GV6P320F</b>	160...320	3 x <b>LC1F185</b>
220	380	220	36	250	401	146	35	<b>GV6P500F</b>	250...500	3 x <b>LC1F265</b>
250	430	250	36	300	480	175	35	<b>GV6P500F</b>	250...500	3 x <b>LC1F330</b>

(1) I<sub>rD</sub>: current in the motor windings in delta connection.

(2) The breaking performance of circuit breakers **GV2ME** can be increased by adding a current limiter **GV1L3**, see page B6/23.

(3) For mounting 3 contactors **LC1D●●A**, star-delta starter kit **LAD9SD3** must be ordered separately, see page B8/29.

#### 1.5 to 250 kW at 400/415 V: type 2 coordination

Maximum operating rate: LC1D: 30 starts/hour; LC1F: 12 starts/hour.

Maximum starting time: LC1D: 30 seconds; LC1F: 20 seconds.

Standard power ratings of 3-phase motors 50-60 Hz in category AC-3								Circuit breaker		Star-delta contactors
400/415 V				440 V				Reference	Setting range of thermal trips	Reference
P	I <sub>e</sub>	I <sub>rD</sub> <sup>(8)</sup>	I <sub>q</sub>	P	I <sub>e</sub>	I <sub>rD</sub> <sup>(8)</sup>	I <sub>q</sub> <sup>(1)</sup>		A	
kW	A	A	kA	kW	A	A	kA			
1.5	3.6	–	130	1.5	3.06	–	130	GV2P08	2.5...4	3 x LC1D09 <sup>(2)</sup>
2.2	4.9	–	130	2.2	4.42	–	130	GV2P10	4...6.3	3 x LC1D18 <sup>(3)</sup>
–	–	–	–	3	5.77	–	130	GV2P10	4...6.3	3 x LC1D18 <sup>(3)</sup>
3	6.5	–	130	–	–	–	–	GV2P14	6...10	3 x LC1D18 <sup>(3)</sup>
4	8.5	–	130	4	7.9	–	130	GV2P14	6...10	3 x LC1D18 <sup>(3)</sup>
5.5	11.5	–	130	5.5	10.4	–	50	GV2P16	9...14	3 x LC1D25 <sup>(3)</sup>
–	–	–	–	7.5	13.7	–	50	GV2P16	9...14	3 x LC1D25 <sup>(3)</sup>
7.5	15.5	–	50	9	16.9	–	20	GV2P20	13...18	3 x LC1D25 <sup>(3)</sup>
9	18.1	–	50	11	20.1	–	20	GV2P21	17...23	3 x LC1D25 <sup>(3)</sup>
11	22	–	50	–	–	–	–	GV2P22	20...25	3 x LC1D25 <sup>(3)</sup>
15	29	–	50	15	26.5	–	50	GV3P32	23...32	3 x LC1D40A <sup>(4)</sup>
18.5	35	–	50	–	–	–	–	GV3P40	30...40	2 x LC1D50A +1 x LC1D40A <sup>(3)</sup>
–	–	–	–	18.5	32.8	–	50	GV3P40	30...40	2 x LC1D65A +1 x LC1D40A <sup>(4)</sup>
22	41	–	50	–	–	–	–	GV3P50	37...50	2 x LC1D50A +1 x LC1D40A <sup>(3)</sup>
–	–	–	–	22	39	–	50	GV3P50	37...50	2 x LC1D65A +1 x LC1D40A <sup>(4)</sup>
30	55	–	50	30	51.5	–	50	GV3P65	48...65	2 x LC1D65A +1 x LC1D40A <sup>(4)</sup>
37	66	–	100	45	76	–	70	GV4P80	40...80	3 x LC1D80 <sup>(5)</sup>
–	–	–	–	37	64	–	70	GV4P80	40...80	3 x LC1D65A <sup>(4)</sup>
45	80	–	100	–	–	–	–	GV4P115	65...115	3 x LC1D115 <sup>(6)</sup>
55	97	–	100	55	90	–	70	GV4P115	65...115	3 x LC1D115 <sup>(6)</sup>
75	132	78	70	75	125	74	65	GV5P150H	70...150	3 x LC1D150 <sup>(6)</sup>
–	–	–	–	90	146	86	65	GV5P150H	70...150	3 x LC1D150 <sup>(6)</sup>
90	160	95	70	110	178	104	65	GV5P220H	100...220	3 x LC1F185 <sup>(7)</sup>
110	195	115	70	132	215	126	65	GV5P220H	100...220	3 x LC1F225 <sup>(7)</sup>
132	230	135	70	–	–	–	–	GV6P320H	160...320	3 x LC1F265
160	270	156	70	160	256	150	65	GV6P320H	160...320	3 x LC1F265
220	380	220	70	250	401	234	65	GV6P500H	250...500	3 x LC1F500
250	430	250	70	300	480	279	65	GV6P500H	250...500	3 x LC1F500

<sup>(1)</sup> The breaking performance of circuit breakers GV2P can be increased by adding a current limiter GV1L3, see page B6/54.

<sup>(2)</sup> For mounting 3 contactors LC1D09, star-delta starter kit LAD91217 must be ordered separately, see page B8/29.

<sup>(3)</sup> For mounting 3 contactors LC1D18 or LC1D25, star-delta starter kit LAD93217 must be ordered separately, see page B8/29.

<sup>(4)</sup> For mounting 3 contactors LC1D65A, star-delta starter kit LAD9SD3 must be ordered separately, see page B8/29.

<sup>(5)</sup> For mounting 3 contactors LC1D80, star-delta starter kit LA9D8017 must be ordered separately, see page B8/29.

<sup>(6)</sup> For mounting 3 contactors LC1D115 or LC1D150, see A2/13.

<sup>(7)</sup> For mounting 3 contactors LC1F185 or LC1F225, see pages A2/15 and A2/17.

<sup>(8)</sup> I<sub>rD</sub>: current in the motor windings in delta connection.

#### 1.5 to 315 kW at 400/415 V: type 1 coordination

Maximum operating rate: LC3K and LC3F: 12 starts/hour; LC3D: 30 starts/hour.

Maximum starting time: LC3K and LC3D: 30 seconds; LC3F: 20 seconds.

Standard power ratings of 3-phase motors 50/60 Hz in category AC-3								Circuit breaker			Star-delta contactors	Thermal overload relay	
400/415 V				440 V				Reference	Rating I <sub>rm</sub> <sup>(2)</sup>		Reference	Reference	Setting range
P	I <sub>e</sub>	I <sub>rD</sub> <sup>(1)</sup>	I <sub>q</sub>	P	I <sub>e</sub>	I <sub>rD</sub> <sup>(1)</sup>	I <sub>q</sub>		A	A			A
kW	A	A	kA	kW	A	A	kA						
–	–	–	–	1.5	3.06	1.8	50	LC3D32A	4	51	LC3K06	LR2K0308	1.8...2.6
1.5	3.6	2	50	2.2	4.42	3	50						
2.2	4.9	3	50	3	5.77	3	50	GV2LE10	6.3	78	LC3K06	LR2K0310	2.6...3.7
3	6.5	4	50	–	–	–	–	GV2LE14	10	138	LC3K06	LR2K0312	3.7...5.5
–	–	–	–	4	7.9	5	50	GV2LE10	6.3	78	LC3K06	LR2K0312	3.7...5.5
4	8.5	5	50	–	–	–	–	GV2LE14	10	138	LC3K06	LR2K0312	3.7...5.5
–	–	–	–	5.5	10.4	6	15	GV2LE14	10	138	LC3K06	LR2K0314	5.5...8
5.5	11.5	6	15	–	–	–	–	GV2LE16	14	170	LC3K06	LR2K0314	5.5...8
–	–	–	–	7.5	13.7	8	8	GV2LE16	14	170	LC3K09	LR2K0316	8...11.5
7.5	15.5	9	15	–	–	–	–	GV2LE20	18	223	LC3K09	LR2K0316	8...11.5
–	–	–	–	9	16.9	1	8	GV2LE16	14	170	LC3D12A	LRD16	9...13
9	18.1	10	15	–	–	–	–	GV2LE22	25	327	LC3K12	LR2K0316	8...11.5
–	–	–	–	11	20.1	12	8	GV2LE20	18	223	LC3K12	LR2K0321	10...14
11	22	12	15	–	–	–	–	GV2LE22	25	327	LC3K12	LR2K0321	10...14
–	–	–	–	15	26.5	15	6	GV2LE22	25	327	LC3D18A	LRD21	12...18
15	29	16	10	–	–	–	–	GV2LE32	32	384	LC3D18A	LRD21	12...18
18.5	35	20	50	18.5	32.8	19	50	GV3L40	40	560	LC3D18A	LRD22	16...24
22	41	24	50	22	39	23	50	GV3L50	50	700	LC3D32A	LRD32	23...32
–	–	–	–	30	51.5	30	50	GV3L65	65	910	LC3D32A	LRD32	23...32
30	55	33	50	–	–	–	–	GV3L65	65	910	LC3D32A	LRD35	30...38
–	–	–	–	37	64	37	50	GV3L65	65	910	3 x LC1D40A <sup>(4)</sup>	LRD340	30...40
37	66	40	100	–	–	–	–	GV4L80	80	640	3 x LC1D40A <sup>(4)</sup>	LRD350	37...50
–	–	–	–	37	64	37	70	GV4L80	80	640	3 x LC1D40A <sup>(4)</sup>	LRD340	30...40
–	–	–	–	45	76	44	70	GV4L80	80	800	2 x LC1D50A +1 x LC1D40A <sup>(4)</sup>	LRD350	30...40
45	80	47	100	–	–	–	–	GV4L115	115	805	2 x LC1D50A +1 x LC1D40A <sup>(4)</sup>	LRD350	30...40
55	97	58	100	55	90	52	70	GV4L115	115	805	2 x LC1D50A +1 x LC1D40A <sup>(4)</sup>	LRD350	30...40
–	–	–	–	75	125	72	<sup>(3)</sup>	NSX160●MA <sup>(3)</sup>	150	1200	LC3D80	LRD3363	63...80
75	132	78	<sup>(3)</sup>	–	–	–	–	NSX160●MA <sup>(3)</sup>	150	1200	LC3D80	LRD3363	63...80
–	–	–	–	90	146	85	<sup>(3)</sup>	NSX160●MA <sup>(3)</sup>	150	1200	LC3D115	LRD4365	80...104
90	160	96	<sup>(3)</sup>	110	178	103	<sup>(3)</sup>	NSX250●MA <sup>(3)</sup>	220	1760	LC3D115	LRD4365	80...104
–	–	–	–	132	215	125	<sup>(3)</sup>	NSX250●MA <sup>(3)</sup>	220	1760	LC3D150	LRD4369	110...140
110	195	116	<sup>(3)</sup>	–	–	–	–	NSX250●MA <sup>(3)</sup>	220	1760	LC3D115	LRD4367	95...120
–	–	–	–	160	256	148	<sup>(3)</sup>	NSX400● + Micrologic 1.3M <sup>(3)</sup>	320	2240	LC3D150	LR9D5369	90...150
–	–	–	–	200	321	186	<sup>(3)</sup>	NSX630● + Micrologic 1.3M <sup>(3)</sup>	500	3150	LC3F225	LR9F5371	132...220
132	230	139	<sup>(3)</sup>	–	–	–	–	NSX400● + Micrologic 1.3M <sup>(3)</sup>	320	2240	LC3D150	LRD4369	110...140
160	280	165	<sup>(3)</sup>	–	–	–	–	NSX400● + Micrologic 1.3M <sup>(3)</sup>	320	2560	LC3F185	LR9F5371	132...220
200	350	204	<sup>(3)</sup>	220	353	204	<sup>(3)</sup>	NSX630● + Micrologic 1.3M <sup>(3)</sup>	500	3150	LC3F225	LR9F5371	132...220
220	388	225	<sup>(3)</sup>	250	401	233	<sup>(3)</sup>	NSX630● + Micrologic 1.3M <sup>(3)</sup>	500	3500	LC3F265	LR9F7375	200...330
280	480	278	<sup>(3)</sup>	–	–	–	–	NSX630● + Micrologic 1.3M <sup>(3)</sup>	500	4000	LC3F330	LR9F7375	200...330
–	–	–	–	315	505	295	<sup>(3)</sup>	NSX800● + Micrologic 5.0 - LR off	800	4000	LC3F330	LR9F7375	200...330
315	540	322	<sup>(3)</sup>	355	518	300	<sup>(3)</sup>	NSX800● + Micrologic 5.0 - LR off	800	4500	LC3F330	LR9F7375	200...330
–	–	–	–	375	575	334	<sup>(3)</sup>	NSX800● + Micrologic 5.0 - LR off	800	5000	LC3F400	LR9F7379	300...500

(1) I<sub>rD</sub>: current in the motor windings in delta connection.

(2) I<sub>rm</sub>: setting current of the magnetic trip.

(3) Products marketed under the Merlin Gerin brand. Reference to be completed by replacing the ● with the breaking performance code:

Breaking performance I <sub>q</sub> (kA)	NSX100●MA		NSX160●MA, NSX250●MA		NSX400●, NSX630●		NS800●	
400/415 V	36	70	36	70	70	150	70	150
440 V	35	65	35	65	65	130	65	130
Code	F	H	F	H	H	L	H	L

(4) For mounting 3 contactors LC1D●●A, star-delta starter kit LAD9SD3 must be ordered separately, see page B8/29.



#### 1.5 to 250 kW at 400/415 V: type 2 coordination

Maximum operating rate: LC3D: 30 starts/hour; LC3F: 12 starts/hour.

Maximum starting time: LC3D: 30 seconds; LC3F: 20 seconds.

Standard power ratings of 3-phase motors  
50/60 Hz in category AC-3

Standard power ratings of 3-phase motors 50/60 Hz in category AC-3						Circuit breaker			Star-delta contactors	Thermal overload relay	
400/415 V			440 V			Reference	Rating	I <sub>rm</sub> <sup>(1)</sup>	Reference	Reference	Setting range
P	I <sub>e</sub>	I <sub>q</sub>	P	I <sub>e</sub>	I <sub>q</sub>		A	A			A
kW	A	kA	kW	A	kA						
1.5	3.6	130	1.5	3.06	130	GV2L08	4	51	3 x LC1D09	LRD08	2.5...4
2.2	4.9	130	2.2	4.42	130	GV2L10	6.3	78	3 x LC1D09	LRD10	4...6
3	6.5	130	3	5.77	130						
–	–	–	4	7.9	20	GV2L14	10	138	3 x LC1D18	LRD14	7...10
4	8.5	130	–	–	–	GV2L14	10	138	3 x LC1D18	LRD16	9...13
5.5	11.5	50	5.5	10.4	20	GV2L16	14	170	3 x LC1D25	LRD16	9...13
7.5	15.5	50	7.5	13.7	20	GV2L20	18	223	3 x LC1D25	LRD21	12...18
–	–	–	9	16.9	20	GV2L22	25	327	3 x LC1D25	LRD21	12...18
9	18.1	50	–	–	–	GV2L22	25	327	3 x LC1D25	LRD22	16...24
11	22	50	11	20.1	20						
15	29	50	15	26.5	50	GV3L32	32	448	3 x LC1D40A <sup>(2)</sup>	LRD332	23...32
18.5	35	50	–	–	–	GV3L40	40	560	2 x LC1D50A +1 x LC1D40A <sup>(2)</sup>	LRD340	30...40
–	–	–	18.5	32.8	50	GV3L40	40	560	2 x LC1D65A +1 x LC1D40A <sup>(2)</sup>	LRD340	30...40
22	41	50	–	–	–	GV3L50	50	700	2 x LC1D50A +1 x LC1D40A <sup>(2)</sup>	LRD350	37...50
–	–	–	22	39	50	GV3L50	50	700	2 x LC1D65A +1 x LC1D40A <sup>(2)</sup>	LRD350	37...50
30	55	50	30	51.5	50	GV3L65	65	910	2 x LC1D65A +1 x LC1D40A <sup>(2)</sup>	LRD365	48...65
–	–	–	37	64	50	GV3L65	65	910	3 x LC1D80	LRD3359	48...65
37	66	100	–	–	–	GV4L80	80	640	3 x LC1D80	LRD3363	63...80
–	–	–	45	76	70	GV4L80	80	800	3 x LC1D80	LRD3363	63...80
45	80	100	–	–	–	GV4L115	115	805	3 x LC1D115	LR9D5367	60...100
–	–	–	55	90	70	GV4L115	115	920	3 x LC1D115	LR9D5367	60...100
55	97	100	–	–	–	GV4L115	115	920	3 x LC1D115	LR9D5369	90...150
55	97	<sup>(3)</sup>	–	–	–	NSX160●MA <sup>(3)</sup>	150	1200	3 x LC1D115	LR9D5369	90...150
–	–	–	75	125	<sup>(3)</sup>	NSX160●MA <sup>(3)</sup>	150	1200	3 x LC1D150	LR9D5369	90...150
75	132	<sup>(3)</sup>	90	146	<sup>(3)</sup>	NSX160●MA <sup>(3)</sup>	150	1200	3 x LC1D150	LR9D5369	90...150
90	160	<sup>(3)</sup>	110	178	<sup>(3)</sup>	NSX250●MA <sup>(3)</sup>	220	1760	3 x LC1F185	LR9F5371	132...220
110	195	<sup>(3)</sup>	–	–	–	NSX250●MA <sup>(3)</sup>	220	1760	3 x LC1F225	LR9F5371	132...220
–	–	–	132	215	<sup>(3)</sup>	NSX250●MA <sup>(3)</sup>	220	1760	3 x LC1F225	LR9F7375	200...330
132	230	<sup>(3)</sup>	160	256	<sup>(3)</sup>	NSX400● + Micrologic 1.3M <sup>(3)</sup>	320	2240	3 x LC1F265	LR9F7375	200...330
160	280	<sup>(3)</sup>	–	–	–	NSX400● + Micrologic 1.3M <sup>(3)</sup>	320	2560	3 x LC1F330	LR9F7375	200...330
–	–	–	200	321	<sup>(3)</sup>	NSX400● + Micrologic 1.3M <sup>(3)</sup>	320	2880	3 x LC1F330	LR9F7379	300...500
200	350	<sup>(3)</sup>	220	353	<sup>(3)</sup>	NSX630● + Micrologic 1.3M <sup>(3)</sup>	500	3150	3 x LC1F400	LR9F7379	300...500
220	388	<sup>(3)</sup>	250	401	<sup>(3)</sup>	NSX630● + Micrologic 1.3M <sup>(3)</sup>	500	3500	3 x LC1F400	LR9F7379	300...500
250	430	<sup>(3)</sup>	–	–	–	NSX630● + Micrologic 1.3M <sup>(3)</sup>	500	4000	3 x LC1F500	LR9F7379	300...500

(1) I<sub>rm</sub>: setting current of the magnetic trip.

(2) For mounting 3 contactors LC1D●●A, star-delta starter kit LAD9SD3 must be ordered separately, see page B8/29.

(3) Products marketed under the Merlin Gerin brand. Reference to be completed by replacing the ● with the breaking performance code:

Breaking performance I <sub>q</sub> (kA)	NSX100●MA		NSX160●MA, NSX250●MA		NSX400●, NSX630●	
400/415 V	36	70	36	70	70	150
440 V	35	65	35	65	65	130
Code	F	H	F	H	H	L



# TeSys island motor starters

Standard, SIL starters - Power interface modules

IEC - Type 1 or 2 coordination with fuses - 690 V

690 V - Type 1 or 2 coordination with fuses			
Applications with 3-phase motors 50-60 Hz in category AC-3	aM fuses	Standard Starters SIL Starters Power Interface Modules	
690 V	Rating	References	Setting range
I <sub>q</sub>			
kA	A		A
80	≤10	TPRST009 TPRSS009 TPRPM009	0.18-9
	≤25	TPRST025 TPRSS025 -	0.5-25
	≤40	TPRST038 TPRSS038 TPRPM038	0.76-38
	≤80	TPRST065 TPRSS065 -	3.25-65
	≤80	TPRST080 TPRSS080 TPRPM080	4-80

# TeSys island motor starters

## Standard, SIL starters - Power interface modules

### IEC - Type 1 coordination with circuit breakers - 230 V

0.06 to 22 kW at 230 V: Type 1 coordination					
Applications power ratings of 3-phase motors 50-60 Hz in category AC-3			Circuit breaker (Trip class 5 to 15)	Standard Starters SIL Starters Power Interface Modules	
230 V			References	References	Setting range
P	I <sub>e</sub>	I <sub>q</sub>			
kW	A	kA			A
0.06	0.35	100	GV2L03	TPRST009 TPRSS009 TPRPM009	0.18-9
0.09	0.52	100	GV2L04	TPRST009 TPRSS009 TPRPM009	0.18-9
0.12	0.7	100	GV2L05	TPRST009 TPRSS009 TPRPM009	0.18-9
0.18	1	100	GV2L06	TPRST009 TPRSS009 TPRPM009	0.18-9
0.25	1.5	100	GV2L06	TPRST009 TPRSS009 TPRPM009	0.18-9
0.37	1.9	100	GV2L07	TPRST009 TPRSS009 TPRPM009	0.18-9
0.55	2.6	100	GV2L08	TPRST009 TPRSS009 TPRPM009	0.18-9
0.75	3.3	100	GV2L08	TPRST009 TPRSS009 TPRPM009	0.18-9
1.1	4.7	100	GV2L10	TPRST009 TPRSS009 TPRPM009	0.18-9
1.5	6.3	100	GV2L14	TPRST009 TPRSS009 TPRPM009	0.18-9
2.2	8.5	100	GV2L14	TPRST009 TPRSS009 TPRPM009	0.18-9
3	11.3	100	GV2L16	TPRST025 TPRSS025 TPRPM038	0.5-25 / 0.76-38
4	15	100	GV2L20	TPRST025 TPRSS025 TPRPM038	0.5-25 / 0.76-38
5.5	20	50	GV2L22	TPRST025 TPRSS025 TPRPM038	0.5-25 / 0.76-38
7.5	27	50	GV2L32	TPRST038 TPRSS038 TPRPM038	0.76-38
9	32	100	GV3L40	TPRST038 TPRSS038 TPRPM038	0.76-38
11	38	100	GV3L40	TPRST065 TPRSS065 TPRPM080	3.25-65 / 4-80
15	51	100	GV3L65	TPRST065 TPRSS065 TPRPM080	3.25-65 / 4-80
18.5	61	100	GV3L65	TPRST065 TPRSS065 TPRPM080	3.25-65 / 4-80
22	72	100	GV3L73	TPRPM080	4-80

# TeSys island motor starters

Standard, SIL starters

IEC - Type 2 coordination with circuit breakers - 230 V

0.06 to 22 kW at 230 V: Type 2 coordination					
Applications power ratings of 3-phase motors 50-60 Hz in category AC-3			Circuit breaker (Trip class 5 to 15)	Standard Starters SIL Starters	
230 V			References	References	Setting range
P	I <sub>e</sub>	I <sub>q</sub>			
kW	A	kA			A
0.06	0.35	100	GV2L03	TPRST009 TPRSS009	0.18-9
0.09	0.52	100	GV2L04	TPRST009 TPRSS009	0.18-9
0.12	0.7	100	GV2L05	TPRST009 TPRSS009	0.18-9
0.18	1	100	GV2L06	TPRST009 TPRSS009	0.18-9
0.25	1.5	100	GV2L06	TPRST009 TPRSS009	0.18-9
0.37	1.9	100	GV2L07	TPRST009 TPRSS009	0.18-9
0.55	2.6	100	GV2L08	TPRST009 TPRSS009	0.18-9
0.75	3.3	100	GV2L08	TPRST025 TPRSS025	0.5-25
1.1	4.7	100	GV2L10	TPRST025 TPRSS025	0.5-25
1.5	6.3	100	GV2L14	TPRST025 TPRSS025	0.5-25
2.2	8.5	100	GV2L14	TPRST025 TPRSS025	0.5-25
3	11.3	100	GV2L16	TPRST025 TPRSS025	0.5-25
4	15	100	GV2L20	TPRST025 TPRSS025	0.5-25
5.5	20	50	GV2L22	TPRST025 TPRSS025	0.5-25
7.5	27	50	GV2L32	TPRST038 TPRSS038	0.76-38
9	32	100	GV3L40	TPRST038 TPRSS038	0.76-38
11	38	100	GV3L40	TPRST065 TPRSS065	3.25-65
15	51	100	GV3L65	TPRST065 TPRSS065	3.25-65
18.5	61	100	GV3L65	TPRST065 TPRSS065	3.25-65

Coordination and standards

# TeSys island motor starters

## Standard, SIL starters - Power interface modules

### IEC - Type 1 coordination with circuit breakers - 400/415 - 440 - 500 V

0.06 to 37 kW at 400/415 - 440 - 500 V: Type 1 coordination											
Applications power ratings of 3-phase motors 50-60 Hz in category AC-3									Circuit breaker (Trip class 5 to 15)	Standard Starters SIL Starters Power Interface Modules	
400/415 V			440 V			500 V			References	References	Setting range
P	I <sub>e</sub>	I <sub>q</sub>	P	I <sub>e</sub>	I <sub>q</sub>	P	I <sub>e</sub>	I <sub>q</sub>			
kW	A	kA	kW	A	kA	kW	A	kA		A	
0.06	0.2	100	0.06	0.18	100	-	-	-	GV2L03	TPRST009 TPRSS009 TPRPM009	0.18-9
0.09	0.3	100	0.09	0.27	100	-	-	-			
0.12	0.44	100	0.12	0.4	100	-	-	-	GV2L04	TPRST009 TPRSS009 TPRPM009	0.18-9
0.18	0.6	100	0.18	0.55	100	-	-	-			
0.25	0.85	100	0.25	0.77	100	-	-	-	GV2L05	TPRST009 TPRSS009 TPRPM009	0.18-9
0.37	1.1	100	-	-	-	0.37	0.88	100			
-	-	-	0.37	1	100	-	-	-	GV2L06	TPRST009 TPRSS009 TPRPM009	0.18-9
0.55	1.5	100	0.55	1.4	100	0.55	1.2	100			
-	-	-	-	-	-	0.75	1.5	100	GV2L07	TPRST009 TPRSS009 TPRPM009	0.18-9
0.75	1.9	100	0.75	1.7	100	-	-	-			
1.1	2.7	100	-	-	-	1.1	2.2	100			
-	-	-	1.1	2.4	100	-	-	-	GV2L08	TPRST009 TPRSS009 TPRPM009	0.18-9
1.5	3.6	100	1.5	3.3	100	1.5	2.9	100			
2.2	4.9	100	2.2	4.5	100	2.2	3.9	100	GV2L10	TPRST009 TPRSS009 TPRPM009	0.18-9
-	-	-	3	5.9	100	3	5.2	100			
3	6.5	100	-	-	-	-	-	-	GV2L14	TPRST009 TPRSS009 TPRPM009	0.18-9
4	8.5	100	4	7.7	20	4	6.8	10			
-	-	-	-	-	-	5.5	9.2	10			
5.5	11.5	50	5.5	10.5	20	-	-	-	GV2L16	TPRST025 TPRSS025 TPRPM038	0.5-25 / 0.76-38
-	-	-	-	-	-	7.5	12.4	10			
7.5	15.5	50	7.5	14.1	20	-	-	-	GV2L20	TPRST025 TPRSS025 TPRPM038	0.5-25 / 0.76-38
-	-	-	9	16.5	20	9	13.9	10			
9	18.1	50	-	-	-	-	-	-	GV2L22	TPRST025 TPRSS025 TPRPM038	0.5-25 / 0.76-38
11	22	50	11	20	20	11	17.6	10			
-	-	-	-	-	-	15	23	10			
15	29	50	15	26.4	20	-	-	-	GV2L32	TPRST038 TPRSS038 TPRPM038	0.76-38
-	-	-	-	-	-	18.5	28	10			
18.5	35	50	18.5	31.8	50	-	-	-	GV3L40	TPRST065 TPRSS065 TPRPM080	3.25-65 / 4-80
-	-	-	-	-	-	22	33	12			
22	41	50	22	37.3	50	-	-	-	GV3L50	TPRST065 TPRSS065 TPRPM080	3.25-65 / 4-80
-	-	-	-	-	-	30	44	12			
30	55	50	30	50	50	-	-	-	GV3L65	TPRST065 TPRSS065 TPRPM080	3.25-65 / 4-80
-	-	-	37	60	50	37	53	12			
37	66	50	-	-	-	-	-	-	GV3L73	TPRST065 TPRSS065 TPRPM080	3.25-65 / 4-80

Coordination and standards

# TeSys island motor starters

## Standard, SIL starters

### IEC - Type 2 coordination with circuit breakers - 400/415 - 440 - 500 V

0.06 to 37 kW at 400/415 - 440 - 500 V: Type 2 coordination										Circuit breaker (Trip class 5 to 15)	Standard Starters SIL Starters	Setting range
Applications power ratings of 3-phase motors 50-60 Hz in category AC-3									References			
400/415 V			440 V			500 V				P	le	Iq
P	Ie	Iq	P	Ie	Iq	P	Ie	Iq	References			
kW	A	kA	kW	A	kA	kW	A	kA			A	
0.06	0.2	100	0.06	0.18	100	-	-	-	GV2L03	TPRST009 TPRSS009	0.18-9	
0.09	0.3	100	0.09	0.27	100	-	-	-				
0.12	0.44	100	0.12	0.4	100	-	-	-	GV2L04	TPRST009 TPRSS009	0.18-9	
0.18	0.6	100	0.18	0.55	100	-	-	-				
0.25	0.85	100	0.25	0.77	100	-	-	-	GV2L05	TPRST009 TPRSS009	0.18-9	
0.37	1.1	100	-	-	-	0.37	0.88	100				
-	-	-	0.37	1	100	-	-	-	GV2L06	TPRST009 TPRSS009	0.18-9	
0.55	1.5	100	0.55	1.4	100	0.55	1.2	100				
-	-	-	-	-	-	0.75	1.5	100	GV2L07	TPRST009 TPRSS009	0.18-9	
0.75	1.9	100	0.75	1.7	100	-	-	-				
						1.1	2.2	100				
1.1	2.7	100	-	-	-	-	-	-	GV2L07	TPRST025 TPRSS025	0.5-25	
-	-	-	1.1	2.4	100	-	-	-	GV2L08	TPRST009 TPRSS009	0.18-9	
-	-	-	-	-	-	1.5	2.9	100				
1.5	3.6	100	1.5	3.3	100	-	-	-	GV2L08	TPRST025 TPRSS025	0.5-25	
2.2	4.9	100	2.2	4.5	100	2.2	3.9	100	GV2L10	TPRST025 TPRSS025	0.5-25	
-	-	-	3	5.9	100	3	5.2	100				
3	6.5	100	-	-	-	-	-	-	GV2L14	TPRST025 TPRSS025	0.5-25	
4	8.5	100	4	7.7	20	4	6.8	10				
-	-	-	-	-	-	5.5	9.2	10				
5.5	11.5	50	5.5	10.5	20	-	-	-	GV2L16	TPRST025 TPRSS025	0.5-25	
-	-	-	-	-	-	7.5	12.4	10				
7.5	15.5	50	7.5	14.1	20	-	-	-	GV2L20	TPRST025 TPRSS025	0.5-25	
-	-	-	9	16.5	20	9	13.9	10				
9	18.1	50	-	-	-	-	-	-	GV2L22	TPRST025 TPRSS025	0.5-25	
11	22	50	11	20	20	11	17.6	10				
-	-	-	-	-	-	15	23	10				
15	29	50	15	26.4	20	-	-	-	GV2L32	TPRST038 TPRSS038	0.76-38	
-	-	-	-	-	-	18.5	28	10				
18.5	35	50	18.5	31.8	50	-	-	-	GV3L40	TPRST065 TPRSS065	3.25-65	
-	-	-	-	-	-	22	33	12				
22	41	50	22	37.3	50	-	-	-	GV3L50	TPRST065 TPRSS065	3.25-65	
-	-	-	-	-	-	30	44	12				
30	55	50	30	50	50	-	-	-	GV3L65	TPRST065 TPRSS065	3.25-65	
-	-	-	37	60	50	37	53	12				
37	66	50	-	-	-	-	-	-	GV3L73	TPRST065 TPRSS065	3.25-65	

Coordination  
and  
standards

# TeSys island motor starters

Standard, SIL starters - Power interface modules

IEC - Type 1 coordination with circuit breakers - 690 V

0.06 to 37 kW at 690 V: Type 1 coordination					
Applications power ratings of 3-phase motors 50-60 Hz in category AC-3			Circuit breaker (Trip class 5 to 15)	Standard Starters SIL Starters Power Interface Modules	
690 V			References	References	Setting range
P	I <sub>e</sub>	I <sub>q</sub>			
kW	A	kA			A
0.37	0.64	100	GV2L05	TPRST009 TPRSS009 TPRPM009	0.18-9
0.55	0.87	4	GV2L05	TPRST009 TPRSS009 TPRPM009	0.18-9
0.75	1.1	4	GV2L06	TPRST009 TPRSS009 TPRPM009	0.18-9
1.1	1.6	4	GV2L07	TPRST009 TPRSS009 TPRPM009	0.18-9
1.5	2.1	4	GV2L07	TPRST009 TPRSS009 TPRPM009	0.18-9
2.2	2.8	4	GV2L08	TPRST009 TPRSS009 TPRPM009	0.18-9
3	3.8	4	GV2L08	TPRST009 TPRSS009 TPRPM009	0.18-9
4	4.9	4	GV2L10	TPRST009 TPRSS009 TPRPM009	0.18-9
5.5	6.7	4	GV2L14	TPRST009 TPRSS009 TPRPM009	0.18-9
7.5	8.9	4	GV2L14	TPRST025 TPRSS025 TPRPM038	0.5-25 / 0.76-38
9	10.5	4	GV2L16	TPRST025 TPRSS025 TPRPM038	0.5-25 / 0.76-38
11	12.8	4	GV2L16	TPRST025 TPRSS025 TPRPM038	0.5-25 / 0.76-38
15	17	4	GV2L20	TPRST025 TPRSS025 TPRPM038	0.5-25 / 0.76-38
18.5	21	4	GV2L22	TPRST038 TPRSS038 TPRPM038	0.76-38
22	24	4	GV2L22	TPRST065 TPRSS065 TPRPM080	3.25-65 / 4-80
30	32	6	GV3L40	TPRST065 TPRSS065 TPRPM080	3.25-65 / 4-80
37	39	6	GV3L50	TPRST065 TPRSS065 TPRPM080	3.25-65 / 4-80

Coordination and standards

# TeSys island motor starters

Standard, SIL starters

IEC - Type 2 coordination with circuit breakers - 690 V

0.06 to 37 kW at 690 V: Type 2 coordination					
Applications power ratings of 3-phase motors 50-60 Hz in category AC-3			Circuit breaker (Trip class 5 to 15)	Standard Starters SIL Starters	
690 V			References	References	Setting range
P	I <sub>e</sub>	I <sub>q</sub>			
kW	A	kA			A
0.37	0.64	100	GV2L05	TPRST009 TPRSS009	0.18-9
0.55	0.87	4	GV2L05	TPRST009 TPRSS009	0.18-9
0.75	1.1	4	GV2L06	TPRST009 TPRSS009	0.18-9
1.1	1.6	4	GV2L07	TPRST009 TPRSS009	0.18-9
1.1	1.6	50	GV2L07 + LA9LB920	TPRST025 TPRSS025	0.5-25
1.5	2.1	4	GV2L07	TPRST009 TPRSS009	0.18-9
1.5	2.1	50	GV2L07 + LA9LB920	TPRST025 TPRSS025	0.5-25
2.2	2.8	4	GV2L08	TPRST025 TPRSS025	0.5-25
2.2	2.8	50	GV2L08 + LA9LB920	TPRST025 TPRSS025	0.5-25
3	3.8	4	GV2L08	TPRST025 TPRSS025	0.5-25
3	3.8	50	GV2L08 + LA9LB920	TPRST025 TPRSS025	0.5-25
4	4.9	4	GV2L10	TPRST025 TPRSS025	0.5-25
4	4.9	50	GV2L10 + LA9LB920	TPRST025 TPRSS025	0.5-25
5.5	6.7	4	GV2L14	TPRST025 TPRSS025	0.5-25
5.5	6.7	50	GV2L14 + LA9LB920	TPRST025 TPRSS025	0.5-25
7.5	8.9	4	GV2L14	TPRST025 TPRSS025	0.5-25
7.5	8.9	50	GV2L14 + LA9LB920	TPRST025 TPRSS025	0.5-25
9	10.5	4	GV2L16	TPRST025 TPRSS025	0.5-25
11	12.8	4	GV2L16	TPRST025 TPRSS025	0.5-25
11	12.8	3	GV3L18+LA9LB920	TPRST038 TPRSS038	0.76-38
15	17	4	GV2L20	TPRST025 TPRSS025	0.5-25
15	17	3	GV2L22 + LA9LB920	TPRST038 TPRSS038	0.76-38
18.5	21	4	GV2L22	TPRST038 TPRSS038	0.76-38
18.5	21	3	GV3L25 + LA9LB920	TPRST065 TPRSS065	3.25-65
22	24	4	GV2L22	TPRST065 TPRSS065	3.25-65
22	24	3	GV2L32 + LA9LB920	TPRST065 TPRSS065	3.25-65
30	32	6	GV3L40	TPRST065 TPRSS065	3.25-65
37	39	6	GV3L50	TPRST065 TPRSS065	3.25-65

Coordination  
and  
standards

# TeSys island motor starters

## Standard, SIL starters - Power interface modules

### UL - SCCR Ratings

#### Short Circuit Current Ratings (SCCR)

UL File E39281 and File E48539 Suitable for use on a circuit delivering not more than:								Standard Starters SIL Starters Power Interface Modules	
High SCCR						Standard SCCR		References	Setting range
Max Voltage 600 V Class J Fuse <sup>(1)</sup>		Max Voltage 480 V Circuit Breaker		Max Voltage 600 V Circuit Breaker		Max Voltage 600 V Circuit Breaker or Fuse			
SCCR	Maximum Amperage	SCCR	Maximum Amperage	SCCR	Maximum Amperage	SCCR	Maximum Amperage		A
kA	A	kA	A	kA	A	kA	A		A
100	25	85	35	50	35	5	35	TPRST009 TPRSS009 TPRPM009	0.18-9
100	60	85	60	50	60	5	100	TPRST025 TPRSS025	0.5-25
100	100	85	60	50	60	5	125	TPRST038 TPRSS038 TPRPM038	0.76-38
100	125	85	110	50	110	5	250	TPRST065 TPRSS065	3.25-65
100	125	85	110	50	110	5	250	TPRST080 TPRSS080 TPRPM080	4-80

(1) When protected by any Class J or CC time-delay fuse (Class CC applicable up to 30 A only).

#### Group Motor Rating

Suitable for group installation on a circuit delivering not more than:				Standard Starters SIL Starters	
Max voltage 600 V - Class J Fuse <sup>(1)</sup>		Max voltage 480 V - Circuit Breaker		References	Setting range
SCCR	Maximum Amperage	SCCR	Maximum Amperage		
kA	A	kA	A		A
5	90	5	90	TPRST009 TPRSS009	0.18-9
5	175	5	175	TPRST025 TPRSS025	0.5-25
5	175	5	175	TPRST038 TPRSS038	0.76-38
5	600	5	600	TPRST065 TPRSS065	3.25-65
5	600	5	600	TPRST080 TPRSS080	4-80

(1) When protected by any Class J or CC time-delay fuse.



#### Contactor utilisation categories conforming to IEC 60947-1

The standard utilisation categories define the current values which the contactor must be able to make or break.

These values depend on:

- the type of load being switched: squirrel cage or slip ring motor, resistors,
- the conditions under which making or breaking takes place: motor stalled, starting or running, reversing, plugging.

#### a.c. applications

<b>Category AC-1</b>	<p>This category applies to all types of a.c. load with a power factor equal to or greater than 0.95 (<math>\cos \varphi \geq 0.95</math>).</p> <p>Application examples: heating, distribution.</p>
<b>Category AC-2</b>	<p>This category applies to starting, plugging and inching of slip ring motors.</p> <ul style="list-style-type: none"> <li>■ On closing, the contactor makes the starting current, which is about 2.5 times the rated current of the motor.</li> <li>■ On opening, it must break the starting current, at a voltage less than or equal to the mains supply voltage.</li> </ul>
<b>Category AC-3</b>	<p>This category applies to squirrel cage motors with breaking during normal running of the motor.</p> <ul style="list-style-type: none"> <li>■ On closing, the contactor makes the starting current, which is about 5 to 7 times the rated current of the motor.</li> <li>■ On opening, it breaks the rated current drawn by the motor.</li> </ul> <p>Application examples: all standard squirrel cage motors: lifts, escalators, conveyor belts, bucket elevators, compressors, pumps, mixers, air conditioning units, etc... .</p>
<b>Category AC-4</b>	<p>This category covers applications with plugging and inching of squirrel cage and slip ring motors. The contactor closes at a current peak which may be as high as 5 or 7 times the rated motor current. On opening it breaks this same current at a voltage which is higher, the lower the motor speed. This voltage can be the same as the mains voltage. Breaking is severe.</p> <p>Application examples: printing machines, wire drawing machines, cranes and hoists, metallurgy industry.</p>

#### d.c. applications

<b>Category DC-1</b>	<p>This category applies to all types of d.c. load with a time constant (L/R) of less than or equal to 1 ms.</p>
<b>Category DC-3</b>	<p>This category applies to starting, counter-current braking and inching of shunt motors. Time constant <math>\leq 2</math> ms.</p> <ul style="list-style-type: none"> <li>■ On closing, the contactor makes the starting current, which is about 2.5 times the rated motor current.</li> <li>■ On opening, the contactor must be able to break 2.5 times the starting current at a voltage which is less than or equal to the mains voltage. The slower the motor speed, and therefore the lower its back e.m.f., the higher this voltage. Breaking is difficult.</li> </ul>
<b>Category DC-5</b>	<p>This category applies to starting, counter-current braking and inching of series wound motors. Time constant <math>\leq 7.5</math> ms.</p> <p>On closing, the contactor makes a starting current peak which may be as high as 2.5 times the rated motor current. On opening, the contactor breaks this same current at a voltage which is higher, the lower the motor speed. This voltage can be the same as the mains voltage. Breaking is severe.</p>

#### Utilisation categories for auxiliary contacts & control relays conforming to IEC 60947-1

#### a.c. applications

<b>Category AC-14<sup>(1)</sup></b>	<p>This category applies to the switching of electromagnetic loads whose power drawn with the electromagnet closed is less than 72 VA.</p> <p>Application example: switching the operating coil of contactors and relays.</p>
<b>Category AC-15<sup>(1)</sup></b>	<p>This category applies to the switching of electromagnetic loads whose power drawn with the electromagnet closed is more than 72 VA.</p> <p>Application example: switching the operating coil of contactors.</p>

#### d.c. applications

<b>Category DC-13<sup>(2)</sup></b>	<p>This category applies to the switching of electromagnetic loads for which the time taken to reach 95 % of the steady state current (<math>T = 0.95</math>) is equal to 6 times the power P drawn by the load (with <math>P \leq 50</math> W).</p> <p>Application example: switching the operating coil of contactors without economy resistor.</p>
-------------------------------------	---

<sup>(1)</sup> Replaces category AC-11.

<sup>(2)</sup> Replaces category DC-11.

# TeSys contactors

## Definitions and comments

### General - Coordination and standards

#### Definitions

<b>Altitude</b>	<p>The rarefied atmosphere at high altitude reduces the dielectric strength of the air and hence the rated operational voltage of the contactor. It also reduces the cooling effect of the air and hence the rated operational current of the contactor (unless the temperature drops at the same time).</p> <p>No derating is necessary up to 3000 m.</p> <p>Derating factors to be applied above this altitude for main pole operational voltage and current (a.c. supply) are as follows.</p> <table border="1"> <thead> <tr> <th>Altitude</th> <th>3500 m</th> <th>4000 m</th> <th>4500 m</th> <th>5000 m</th> </tr> </thead> <tbody> <tr> <td>Rated operational voltage</td> <td>0.90</td> <td>0.80</td> <td>0.70</td> <td>0.60</td> </tr> <tr> <td>Rated operational current</td> <td>0.92</td> <td>0.90</td> <td>0.88</td> <td>0.86</td> </tr> </tbody> </table>	Altitude	3500 m	4000 m	4500 m	5000 m	Rated operational voltage	0.90	0.80	0.70	0.60	Rated operational current	0.92	0.90	0.88	0.86
Altitude	3500 m	4000 m	4500 m	5000 m												
Rated operational voltage	0.90	0.80	0.70	0.60												
Rated operational current	0.92	0.90	0.88	0.86												
<b>Ambient air temperature</b>	<p>The temperature of the air surrounding the device, measured near to the device.</p> <p>The operating characteristics are given:</p> <ul style="list-style-type: none"> <li>- with no restriction for temperatures between -5 and +55 °C,</li> <li>- with restrictions, if necessary, for temperatures between -50 and +70 °C.</li> </ul>															
<b>Rated operational current (Ie)</b>	This is defined taking into account the rated operational voltage, operating rate and duty, utilisation category and ambient temperature around the device.															
<b>Rated conventional thermal current (Ith) <sup>(1)</sup></b>	The current which a closed contactor can sustain for a minimum of 8 hours without its temperature rise exceeding the limits given in the standards.															
<b>Permissible short time rating</b>	The current which a closed contactor can sustain for a short time after a period of no load, without dangerous overheating.															
<b>Rated operational voltage (Ue)</b>	<p>This is the voltage value which, in conjunction with the rated operational current, determines the use of the contactor or starter, and on which the corresponding tests and the utilisation category are based. For 3-phase circuits it is expressed as the voltage between phases.</p> <p>Apart from exceptional cases such as rotor short-circuiting, the rated operational voltage Ue is less than or equal to the rated insulation voltage Ui.</p>															
<b>Rated control circuit voltage (Uc)</b>	The rated value of the control circuit voltage, on which the operating characteristics are based. For a.c. applications, the values are given for a near sinusoidal wave form (less than 5 % total harmonic distortion).															
<b>Rated insulation voltage (Ui)</b>	This is the voltage value used to define the insulation characteristics of a device and referred to in dielectric tests determining leakage paths and creepage distances. As the specifications are not identical for all standards, the rated value given for each of them is not necessarily the same.															
<b>Rated impulse withstand voltage (Uimp)</b>	The peak value of a voltage surge which the device is able to withstand without breaking down.															
<b>Rated operational power (expressed in kW)</b>	The rated power of the standard motor which can be switched by the contactor, at the stated operational voltage.															

<sup>(1)</sup> Conventional thermal current, in free air, conforming to IEC standards.

**Note:** these definitions are extracted from standard IEC 60947-1.

# TeSys contactors

## Definitions and comments

### General - Coordination and standards

#### Definitions

<b>Rated breaking capacity</b> <sup>(1)</sup>	This is the current value which the contactor can break in accordance with the breaking conditions specified in the IEC standard.
<b>Rated making capacity</b> <sup>(1)</sup>	This is the current value which the contactor can make in accordance with the making conditions specified in the IEC standard.
<b>On-load factor</b> (m)	<div style="display: flex; align-items: center;"> <div style="flex: 1;"> </div> <div style="flex: 1; padding-left: 20px;"> <p>This is the ratio between the time the current flows (t) and the duration of the cycle (T). Cycle duration: duration of current flow + time at zero current.</p> </div> </div>
<b>Pole impedance</b>	<p>The impedance of one pole is the sum of the impedance of all the circuit components between the input terminal and the output terminal.</p> <p>The impedance comprises a resistive component (R) and an inductive component (<math>X = L\omega</math>).</p> <p>The total impedance therefore depends on the frequency and is normally given for 50 Hz.</p> <p>This average value is given for the pole at its rated operational current.</p>
<b>Electrical durability</b>	This is the average number of on-load operating cycles which the main pole contacts can perform without maintenance. The electrical durability depends on the utilisation category, the rated operational current and the rated operational voltage.
<b>Mechanical durability</b>	This is the average number of no-load operating cycles (i.e. with zero current flow through the main poles) which the contactor can perform without mechanical failure.

<sup>(1)</sup> For a.c. applications, the breaking and making capacities are expressed by the rms value of the symmetrical component of the short-circuit current. Taking into account the maximum asymmetry which may exist in the circuit, the contacts therefore have to withstand a peak asymmetrical current which may be twice the rms symmetrical component.

**Note:** these definitions are extracted from standard IEC 60947-1.

# TeSys contactors

## For utilisation category AC-3

### Selection - Coordination and standards

#### Operational current and power conforming to IEC ( $\theta \leq 60^\circ\text{C}$ )

Contactor size			LC1/ LP1 K06	LC1/ LP1 K09	LC1 K12	LC1 K16	LC1 D09	LC1 D12	LC1 D18	LC1 D25	LC1 D32	LC1 D38	LC1 D40A
Maximum operational current in AC-3	$\leq 440\text{ V}$	<b>A</b>	6	9	12	16	9	12	18	25	32	38	40
Rated operational power P (standard motor power ratings)	220/240 V	<b>kW</b>	1.5	2.2	3	3	2.2	3	4	5.5	7.5	9	11
	380/400 V	<b>kW</b>	2.2	4	5.5	7.5	4	5.5	7.5	11	15	18.5	18.5
	415 V	<b>kW</b>	2.2	4	5.5	7.5	4	5.5	9	11	15	18.5	22
	440 V	<b>kW</b>	3	4	5.5	7.5	4	5.5	9	11	15	18.5	22
	500 V	<b>kW</b>	3	4	4	5.5	5.5	7.5	10	15	18.5	18.5	22
	660/690 V	<b>kW</b>	3	4	4	4	5.5	7.5	10	15	18.5	18.5	30
	1000 V	<b>kW</b>	–	–	–	–	–	–	–	–	–	–	–

#### Maximum operating rate in operating cycles/hour<sup>(1)</sup>

On-load factor	Operational power	LC1 D09	LC1 D12	LC1 D18	LC1 D25	LC1 D32	LC1 D38	LC1 D40A				
$\leq 85\%$	P	–	–	–	–	1200	1200	1200	1200	1000	1000	1000
	0.5 P	–	–	–	–	3000	3000	2500	2500	2500	2500	2500
$\leq 25\%$	P	–	–	–	–	1800	1800	1800	1800	1200	1200	1200

#### Operational current and power conforming to UL, CSA ( $\theta \leq 60^\circ\text{C}$ )

Contactor size			LC1/ LP1 K06	LC1/ LP1 K09	LC1/ LP1 K12	LC1 D09	LC1 D12	LC1 D18	LC1 D25	LC1 D32	LC1 D38	LC1 D40A
Maximum operational current in AC-3	$\leq 440\text{ V}$	<b>A</b>	6	9	12	9	12	18	25	32	–	40
Rated operational power P (standard motor power ratings 60 Hz)	200/208 V	<b>HP</b>	1.5	2	3	2	3	5	7.5	10	–	10
	230/240 V	<b>HP</b>	1.5	3	3	2	3	5	7.5	10	–	10
	460/480 V	<b>HP</b>	3	5	7.5	5	7.5	10	15	20	–	30
	575/600 V	<b>HP</b>	3	5	10	7.5	10	15	20	25	–	30

(1) Depending on the operational power and the on-load factor ( $\theta \leq 60^\circ\text{C}$ ).

(2) Other values: please contact us.

# TeSys contactors

For utilisation category AC-3

## Selection - Coordination and standards

LC1 D50A	LC1 D65A	LC1 D80A	LC1 D80	LC1 D95	LC1 D115	LC1 D150	LC1 F185	LC1 F225	LC1 F265	LC1 F330	LC1 F400	LC1 F500	LC1 F630	LC1 F780	LC1 F800	LC1 F1000	LC1 BL	LC1 BM	LC1 BP	LC1 BR
50	65	80	80	95	115	150	185	225	265	330	400	500	630	780	800	1000	750	1000	1500	1800
15	18,5	22	22	25	30	40	55	63	75	100	110	147	200	220	250	315	220	280	425	500
22	30	37	37	45	55	75	90	110	132	160	200	250	335	400	450	560	400	500	750	900
25	37	37	45	45	59	80	100	110	140	180	220	280	375	425	450	630	425	530	800	900
30	37	37	45	45	59	80	100	110	140	200	250	295	400	425	450	670	450	560	800	900
30	37	37	55	55	75	90	110	129	160	200	257	355	400	450	450	-	500	600	750	900
33	37	37	45	45	80	100	110	129	160	220	280	335	450	475	475	-	560	670	750	900
-	-	-	45	45	65	75	-	-	-	160	185	-	450	450	450	-	530	530	670	750

LC1 D50A	LC1 D65A	LC1 D80A	LC1 D80	LC1 D95	LC1 D115	LC1 D150	LC1 F185	LC1 F225	LC1 F265	LC1 F330	LC1 F400	LC1 F500	LC1 F630	LC1 F780	LC1 F800	LC1 F1000	LC1 BL	LC1 BM	LC1 BP	LC1 BR
1000	1000	1000	750	750	750	750	750	750	750	750	500	500	500	500	500	(2)	120	120	120	120
2500	2500	2500	2000	2000	2000	1200	2000	2000	2000	2000	1200	1200	1200	1200	600	(2)	120	120	120	120
1200	1200	1200	1200	1200	1200	1200	1200	1200	1200	1200	1200	1200	1200	600	600	(2)	120	120	120	120

LC1 D50A	LC1 D65A	LC1 D80A	LC1 D80	LC1 D95	LC1 D115	LC1 D150	LC1 F185	LC1 F225	LC1 F265	LC1 F330	LC1 F400	LC1 F500	LC1 F630	LC1 F780	LC1 F800	LC1 F1000
50	65	65	80	95	115	150	185	225	265	330	400	500	630	780	800	1000
15	20	20	30	30	30	40	50	60	60	75	100	150	250	-	350	350
15	20	20	30	30	40	50	60	75	75	100	125	200	300	450	400	400
40	40	40	60	60	75	100	125	150	150	200	250	400	600	900	900	900
40	50	50	60	60	100	125	150	150	200	250	300	500	800	900	900	-

Coordination and standards

# TeSys contactors

## For utilisation category AC-3

### Selection - Coordination and standards

#### Selection according to required electrical durability, in category AC-3 ( $U_e \leq 440\text{ V}$ )

Control of 3-phase asynchronous squirrel cage motors with breaking whilst running.  
 The current broken ( $I_c$ ) in category AC-3 is equal to the rated operational current ( $I_e$ ) of the motor.

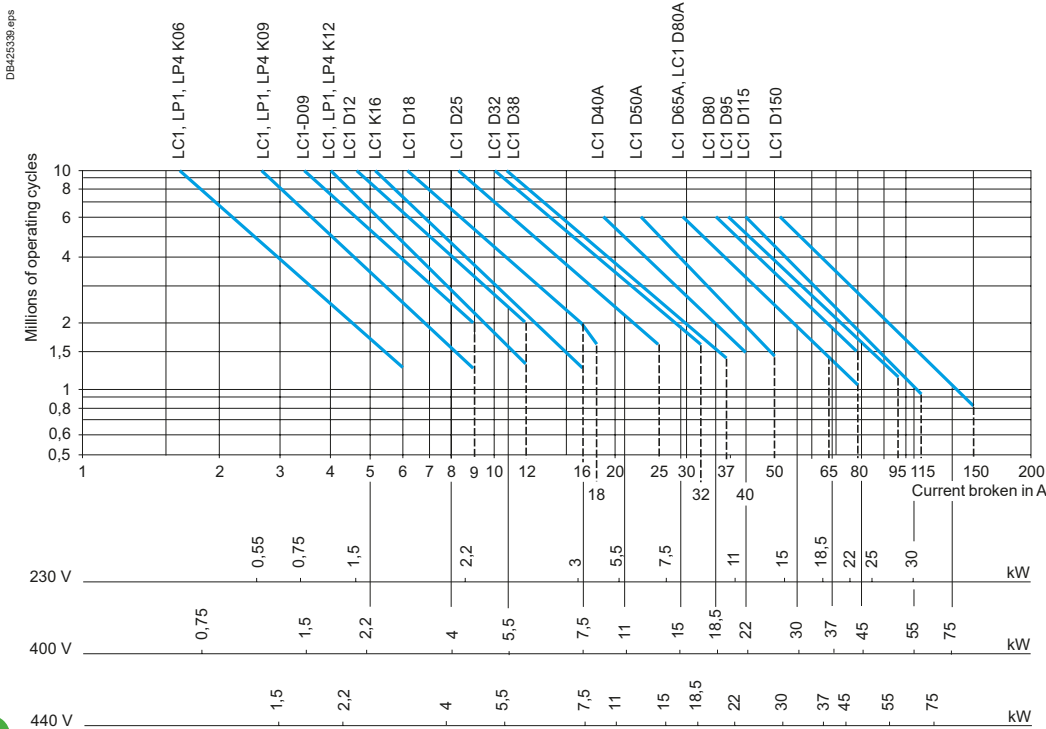

Operational power in kW-50 Hz.

#### Example:

Asynchronous motor with  $P = 5.5\text{ kW}$  -  $U_e = 400\text{ V}$  -  $I_e = 11\text{ A}$  -  $I_c = I_e = 11\text{ A}$   
 or asynchronous motor with  $P = 5.5\text{ kW}$  -  $U_e = 415\text{ V}$  -  $I_e = 11\text{ A}$  -  $I_c = I_e = 11\text{ A}$   
 3 million operating cycles required.

The above selection curves show the contactor rating needed: LC1D18.

#### Selection according to required electrical durability, in category AC-3 ( $U_e = 660/690\text{ V}$ )<sup>(1)</sup>

Control of 3-phase asynchronous squirrel cage motors with breaking whilst running.  
 The current broken ( $I_c$ ) in category AC-3 is equal to the rated operational current ( $I_e$ ) of the motor.

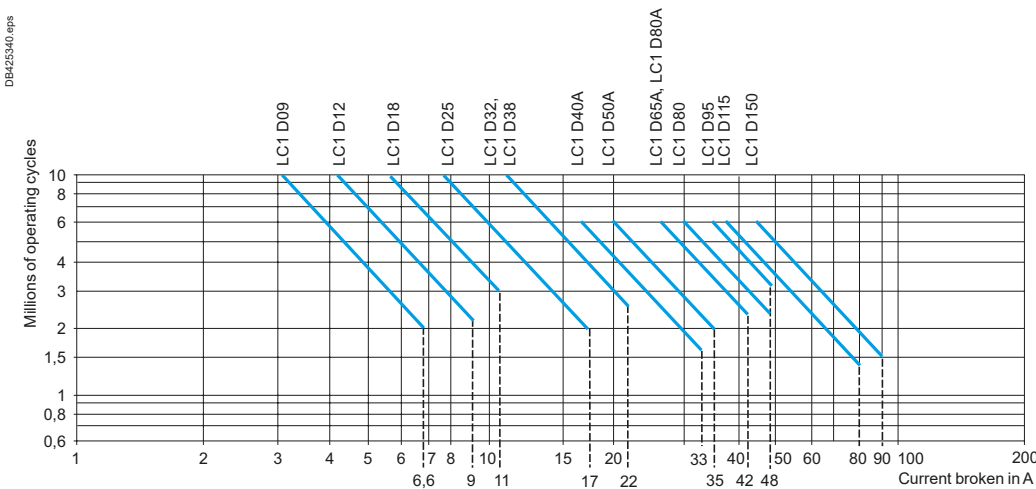

<sup>(1)</sup> For  $U_e = 1000\text{ V}$ , use the 660/690 V curves, but do not exceed the operational current at the operational power indicated for 1000 V.

# TeSys contactors

## For utilisation category AC-3

### Selection - Coordination and standards

#### Selection according to required electrical durability, in category AC-3 ( $U_e \leq 440$ V)

Control of 3-phase asynchronous squirrel cage motors with breaking whilst running.  
The current broken ( $I_c$ ) in category AC-3 is equal to the rated operational current ( $I_e$ ) of the motor.

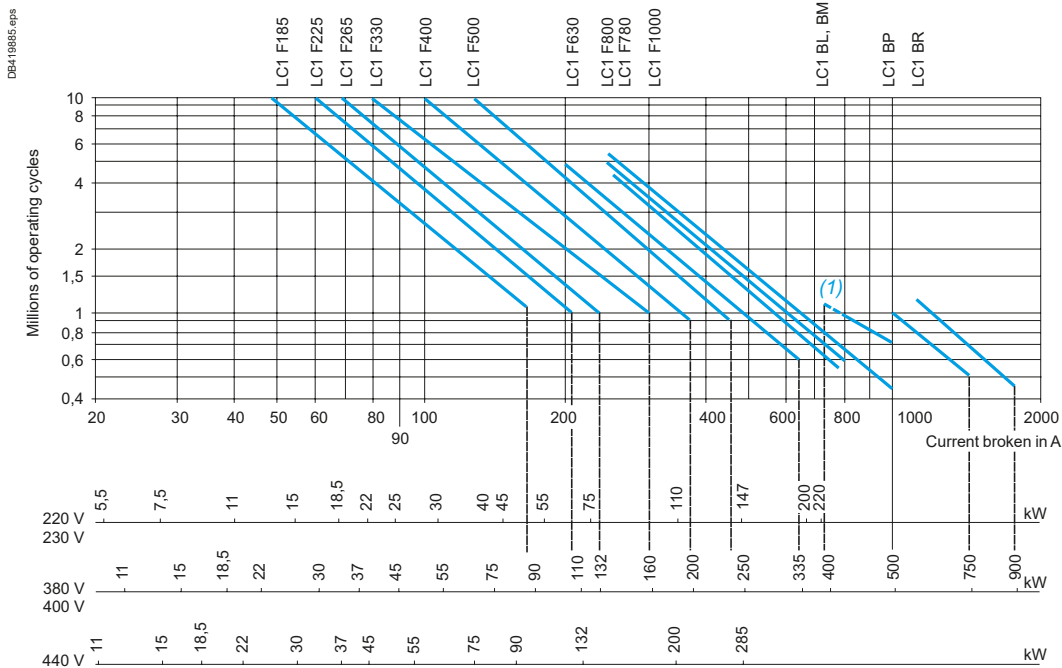

Operational power in kW-50 Hz.

#### Example:

Asynchronous motor with  $P = 132$  kW -  $U_e = 380$  V -  $I_e = 245$  A -  $I_c = I_e = 245$  A  
or asynchronous motor with  $P = 132$  kW -  $U_e = 415$  V -  $I_e = 240$  A -  $I_c = I_e = 240$  A  
1.5 million operating cycles required.

The above selection curves show the contactor rating needed: LC1F330.

(1) The dotted lines are only applicable to LC1BL contactors.

Coordination  
and  
standards

#### Selection according to required electrical durability, in category AC-3 ( $U_e = 660/690$ V)

Control of 3-phase asynchronous squirrel cage motors with breaking whilst running.  
The current broken ( $I_c$ ) in category AC-3 is equal to the rated operational current ( $I_e$ ) of the motor.

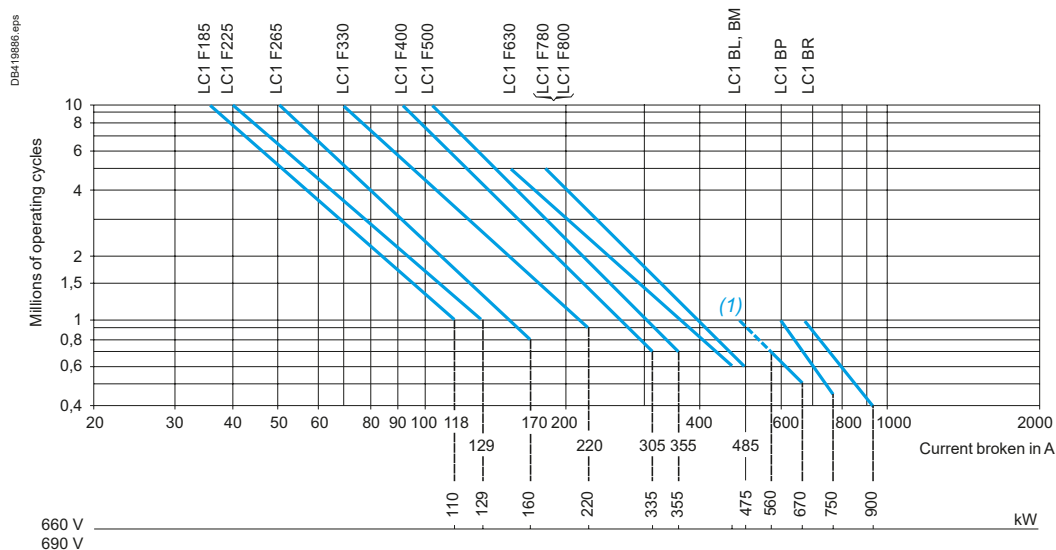

#### Example:

Asynchronous motor with  $P = 132$  kW -  $U_e = 660$  V -  $I_e = 140$  A -  $I_c = I_e = 140$  A  
1.5 million operating cycles required.

The above selection curves show the contactor rating needed: LC1F330.

(1) The dotted lines are only applicable to LC1BL contactors.

# TeSys contactors

For utilisation category AC-1

## Selection - Coordination and standards

### Maximum operational current (open-mounted device)

Contactor size		LC1/LP1 K09	LC1/LP1 K12	LC1 D09	LC1 DT20	LC1 D12 DT25	LC1 D18 DT32	LC1 D25 DT40	LC1 D32	LC1 D38	LC1 D40A DT60A	LC1 D50A	
Maximum operating rate in operating cycles/hour		600	600	600	600	600	600	600	600	600	600	600	
Connection conforming to IEC 60947-1	Cable c.s.a. <b>mm<sup>2</sup></b>	4	4	4	4	4	6	6	10	10	35	35	
	Bar c.s.a. <b>mm</b>	-	-	-	-	-	-	-	-	-	-	-	
Operational current in AC-1 in A, according to the ambient temperature conforming to IEC 60947-1	≤ 40 °C	<b>A</b>	20	20	25	20	25	32	40	50	50	60	80
	≤ 60 °C	<b>A</b> <sup>(4)</sup>	20	20	25	20	25	32	40	50	50	60	80
	≤ 70 °C	<b>A</b> <sup>(4)</sup>	<sup>(1)</sup>	<sup>(1)</sup>	17	<sup>(1)</sup>	17	22	28	35	35	42	56
Maximum operational power ≤ 60 °C	220/230 V	<b>kW</b>	8	8	9	8	9	11	14	18	18	21	29
	240 V	<b>kW</b>	8	8	9	8	9	12	15	19	19	23	31
	380/400 V	<b>kW</b>	14	14	15	14	15	20	25	31	31	37	50
	415 V	<b>kW</b>	14	14	17	14	17	21	27	34	34	41	54
	440 V	<b>kW</b>	15	15	18	15	18	23	29	36	36	43	58
	500 V	<b>kW</b>	17	17	20	17	20	23	33	41	41	49	65
	660/690 V	<b>kW</b>	22	22	27	22	27	34	43	54	54	65	80
	1000 V	<b>kW</b>	-	-	-	-	-	-	-	-	-	-	-

<sup>(1)</sup> Please consult your Regional Sales Office.

<sup>(2)</sup> With set of right-angled connectors LA9F2100.

<sup>(3)</sup> With set of right-angled connectors LA9F2600.

<sup>(4)</sup> LC1F115 to LC1F2600: maximum coil control voltage must not exceed rated U<sub>c</sub> for temperature ≥ 60 °C.

### Increase in operational current by parallel connection of poles

Apply the following coefficients to the currents or power values given above; these coefficients take into account an often unbalanced current distribution between the poles:

- 2 poles in parallel: K = 1.6
- 3 poles in parallel: K = 2.25
- 4 poles in parallel: K = 2.8

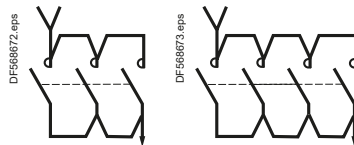

### Selection according to required electrical durability, in category AC-1 (U<sub>e</sub> ≤ 690 V)

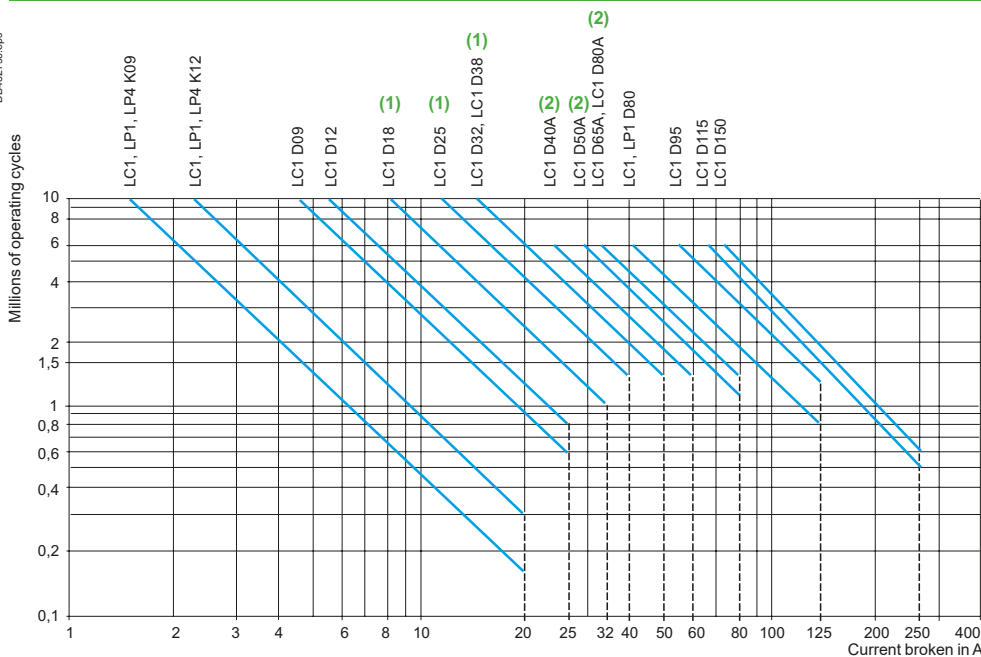

<sup>(1)</sup> For TeSys D Green, consult online datasheets for values.

<sup>(2)</sup> For TeSys D Green or DC coil, consult online datasheets for values.

Control of resistive circuits (cos φ ≥ 0.95).

The current broken (I<sub>c</sub>) in category AC-1 is equal to the current (I<sub>e</sub>) normally drawn by the load.

#### Example:

- U<sub>e</sub> = 220 V - I<sub>e</sub> = 50 A θ ≤ 40 °C - I<sub>c</sub> = I<sub>e</sub> = 50 A
- 2 million operating cycles required
- the above selection curves show the contactor rating needed: LC1D50A.



# TeSys contactors

## For utilisation category AC-1

### Selection - Coordination and standards

LC1 D65A D80A DT80A	LC1 LP1 D80	LC1 D95	LC1 D115	LC1 D150	LC1 F185	LC1 F225	LC1 F265	LC1 F330	LC1 F400	LC1 F500	LC1 F630	LC1 F780	LC1 F800	LC1 F1000	LC1S F1200	LC1 F1250	LC1 F1400	LC1 F1700	LC1 F2100	LC1 F2600	LC1 BL	LC1 BM	LC1 BP	LC1 BR
600	600	600	600	600	600	600	600	600	600	600	600	600	600	300	300	200	200	200	200	200	120	120	120	120
35	50	50	120	120	150	185	185	240	-	-	-	-	-	-	-	-	-	-	-	-	-	-	-	-
-	-	-	-	-	-	-	-	-	2	2	2	2	2	3	2	2	2	3	4	3	2	2	2	2
-	-	-	-	-	-	-	-	-	30x5	40x5	60x5	100x5	60x5	100x5	50x8	100x5	100x5	100x5	100x5	100x10	50x5	80x5	100x5	100x10
80	125	125	250	250	275	315	350	400	500	700	1000	1600	1000	1250	1200	1260	1400	1700	2100 <sup>(2)</sup>	2600	800	1250	2000	2750
80	125	125	200	200	240	280	300	360	430	580	850	1350	850	<sup>(1)</sup>	1110	1060	1190	1450	1750 <sup>(2)</sup>	2600 <sup>(3)</sup>	700	1100	1750	2400
56	80	80	160	160	180	200	250	290	340	500	700	1100	700	<sup>(1)</sup>	1020	900	1080	1300	1500 <sup>(2)</sup>	2150 <sup>(3)</sup>	600	900	1500	2000
29	45	45	80	80	90	100	120	145	170	240	350	550	350	<sup>(1)</sup>	400	420	474	570	700	840	300	425	700	1000
31	49	49	83	83	100	110	125	160	180	255	370	570	370	<sup>(1)</sup>	410	440	490	600	780	920	330	450	800	1100
50	78	78	135	135	165	175	210	250	300	430	600	950	600	<sup>(1)</sup>	700	730	820	1000	1200	1450	500	800	1200	1600
54	85	85	140	140	170	185	220	260	310	445	630	1000	630	<sup>(1)</sup>	720	760	850	1050	1300	1580	525	825	1250	1700
58	90	90	150	150	180	200	230	290	330	470	670	1050	670	<sup>(1)</sup>	750	810	910	1100	1350	1680	550	850	1400	2000
65	102	102	170	170	200	220	270	320	380	502	750	1200	750	-	850	920	1000	1250	1550	1910	600	900	1500	2100
80	135	135	235	235	280	300	370	400	530	740	1000	1650	1000	-	1200	1260	1400	1700	2100	2520	800	1100	1900	2700
-	120	120	345	345	-	-	540	640	760	950	1500	2400	1500	-	-	-	2100	2500	3100 <sup>(2)</sup>	3820	1100	1700	3000	4200

(1) Please consult your Regional Sales Office.

(2) With set of right-angled connectors LA9F2100.

(3) With set of right-angled connectors LA9F2600.

(4) LC1F115 to LC1F2600: maximum coil control voltage must not exceed rated U<sub>c</sub> for temperature ≥ 60 °C.

### Selection according to required electrical durability, in category AC-1 (U<sub>e</sub> ≤ 690 V)

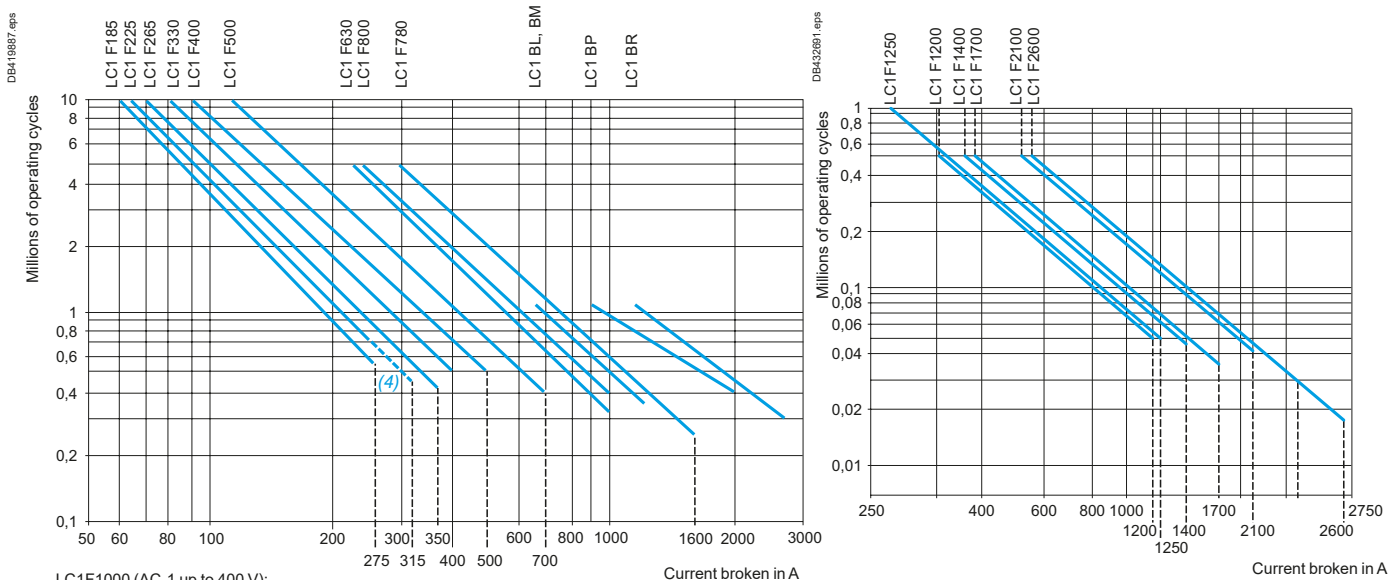

#### Example:

- U<sub>e</sub> = 220 V - I<sub>e</sub> = 500 A - θ ≤ 40 °C - I<sub>c</sub> = I<sub>e</sub> = 500 A
  - 2 million operating cycles required
  - the above selection curves show the contactor rating needed: LC1F780.
- (1) Please consult your Regional Sales Office  
 (2) With set of right-angled connectors LA9F2100  
 (3) With set of right-angled connectors LA9F2600  
 (4) The dotted lines are only applicable to LC1F225.

# TeSys contactors

For utilisation categories AC-2 or AC-4

## Selection - Coordination and standards

### Maximum breaking current

Category AC-2: slip ring motors - breaking the starting current.

Category AC-4: squirrel cage motors - breaking the starting current.

Contactor size			LC1/ LP1 K06	LC1/ LP1 K09	LC1/ LP1 K12	LC1 D09	LC1 D12	LC1 D18	LC1 D25	LC1 D32	LC1 D38	LC1 D40A
In category AC-4 (Ie max)	Ue ≤ 440 V Ie max broken = 6 x I motor	A	36	54	54	54	72	108	150	192	192	240
	440 V < Ue ≤ 690 V Ie max broken = 6 x I motor	A	26	40	40	40	50	70	90	105	105	150

### Depending on the maximum operating rate <sup>(1)</sup> and the on-load factor, $\theta \leq 60^\circ\text{C}$ <sup>(2)</sup>

From 150 and 15 % to 300 and 10 %	A	20	30	30	30	40	45	75	80	80	110
From 150 and 20 % to 600 and 10 %	A	18	27	27	27	36	40	67	70	70	96
From 150 and 30 % to 1200 and 10 %	A	16	24	24	24	30	35	56	60	60	80
From 150 and 55 % to 2400 and 10 %	A	13	19	19	19	24	30	45	50	50	62
From 150 and 85 % to 3600 and 10 %	A	10	16	16	16	21	25	40	45	45	53

(1) Do not exceed the maximum number of operating cycles.

(2) For temperatures higher than 60 °C, use a maximum operating rate value equal to 80 % of the actual value when selecting from the tables.

### Counter current braking (plugging)

The current varies from the maximum plug-braking current to the rated motor current.

The making current must be compatible with the rated making and breaking capacities of the contactor.

As breaking normally takes place at a current value at or near the locked rotor current, the contactor can be selected using the criteria for categories AC-2 and AC-4.

### Permissible AC-4 power rating for 200 000 operating cycles

Operational voltage		LC●/ LP● K06	LC●/ LP● K09	LC● LP● K12	LC● D09	LC● D12	LC● D18	LC● D25	LC● D32	LC● D38	LC● D40A
220/230 V	kW	0.75	1.1	1.1	1.5	1.5	2.2	3	4	4	4
380/400 V	kW	1.5	2.2	2.2	2.2	3.7	4	5.5	7.5	7.5	9
415 V	kW	1.5	2.2	2.2	2.2	3	3.7	5.5	7.5	7.5	9
440 V	kW	1.5	2.2	2.2	2.2	3	3.7	5.5	7.5	7.5	11
500 V	kW	2.2	3	3	3	4	5.5	7.5	9	9	11
660/690 V	kW	3	4	4	4	5.5	7.5	10	11	11	15

# TeSys contactors

For utilisation categories AC-2 or AC-4

Selection - Coordination and standards

LC1 D50A	LC1 D65A	LC1 D80A	LC1 D80	LC1 D95	LC1 D115	LC1 D150	LC1 F185	LC1 F225	LC1 F26	LC1 F330	LC1 F40	LC1 F500	LC1 F630	LC1 F780	LC1 F800	LC1 BL	LC1 BM	LC1 BP	LC1 BR
300	390	390	480	570	630	830	1020	1230	1470	1800	2220	2760	3360	4260	3690	4320	5000	7500	9000
170	210	210	250	250	540	640	708	810	1020	1410	1830	2130	2760	2910	2910	4000	4800	5400	6600
140	160	160	200	200	280	310	380	420	560	670	780	1100	1400	1600	1600	2250	3000	4500	5400
120	148	148	170	170	250	280	350	400	500	600	700	950	1250	1400	1400	2000	2400	3750	5000
100	132	132	145	145	215	240	300	330	400	500	600	750	950	1100	1100	1500	2000	3000	3600
80	110	110	120	120	150	170	240	270	320	390	450	600	720	820	820	1000	1500	2000	2500
70	90	90	100	100	125	145	170	190	230	290	350	500	660	710	710	750	1000	1500	1800

LC● D50A	LC● D65A	LC1 D80A	LC● D80	LC● D95	LC1 D115	LC1 D150	LC1 F185	LC1 F225	LC1 F265	LC1 F330	LC1 F400	LC1 F500	LC1 F630	LC1 F780	LC1 F800	LC1 BL	LC1 BM	LC1 BP	LC1 BR
5.5	7.5	7.5	7.5	9	9	11	18.5	22	28	33	40	45	55	63	63	90	110	150	200
11	11	11	15	15	18.5	22	33	40	51	59	75	80	100	110	110	160	160	220	250
11	11	11	15	15	18.5	22	37	45	55	63	80	90	100	110	110	160	160	250	280
11	15	15	15	15	18.5	22	37	45	59	63	80	100	110	132	132	160	200	250	315
15	15	15	22	22	30	37	45	55	63	75	90	110	132	150	150	180	200	250	355
15	18.5	18.5	25	25	30	45	63	75	90	110	129	140	160	185	185	200	250	315	450

Coordination  
and  
standards

# TeSys contactors

For utilisation categories AC-2 or AC-4

## Selection - Coordination and standards

### Selection according to required electrical durability, in categories AC-2 or AC-4 ( $U_e \leq 440\text{ V}$ )

Control of 3-phase asynchronous squirrel cage motors (AC-4) or slip ring motors (AC-2) with breaking whilst motor stalled.  
The current broken ( $I_c$ ) in AC-2 is equal to  $2.5 \times I_e$ .  
The current broken ( $I_c$ ) in AC-4 is equal to  $6 \times I_e$  ( $I_e$  = rated operational current of the motor).

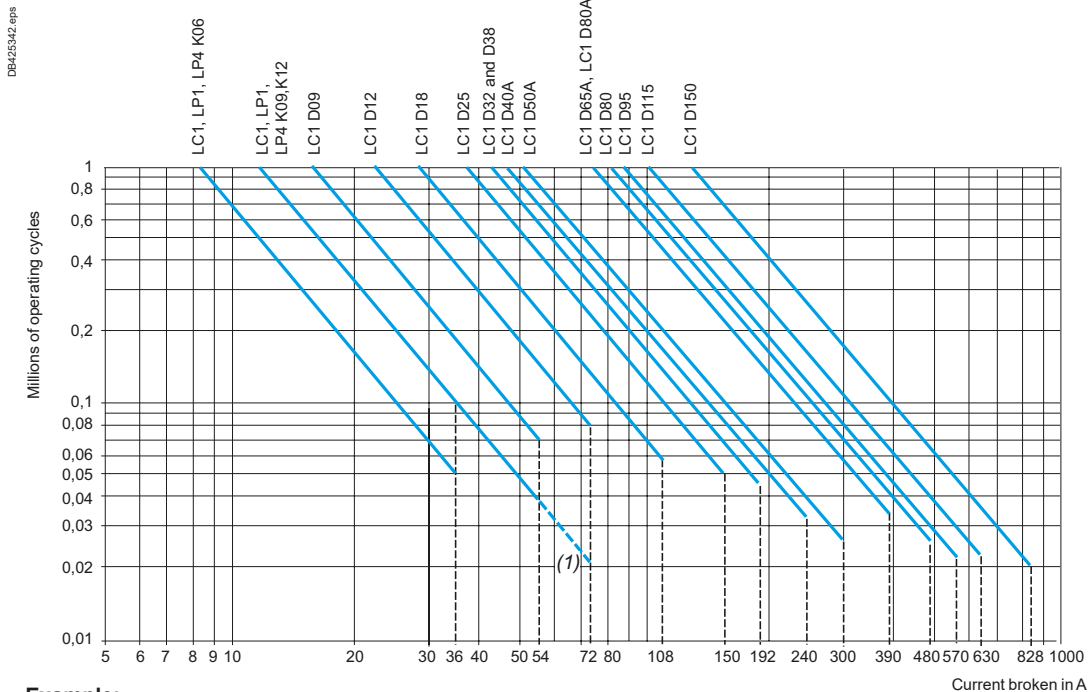

#### Example:

- asynchronous motor with  $P = 5.5\text{ kW}$  -  $U_e = 400\text{ V}$  -  $I_e = 11\text{ A}$ .  $I_c = 6 \times I_e = 66\text{ A}$
- or asynchronous motor with  $P = 5.5\text{ kW}$  -  $U_e = 415\text{ V}$  -  $I_e = 11\text{ A}$ .  $I_c = 6 \times I_e = 66\text{ A}$
- 200 000 operating cycles required
- the above selection curves show the contactor rating needed: LC1D25.

(1) The dotted lines are only applicable to LC1, LP1K12 contactors.

### Selection according to required electrical durability, use in category AC-4 ( $440\text{ V} < U_e \leq 690\text{ V}$ )

Control of 3-phase asynchronous squirrel cage motors with breaking whilst motor stalled.  
The current broken ( $I_c$ ) in AC-2 is equal to  $2.5 \times I_e$ .  
The current broken ( $I_c$ ) in AC-4 is equal to  $6 \times I_e$  ( $I_e$  = rated operational current of the motor).

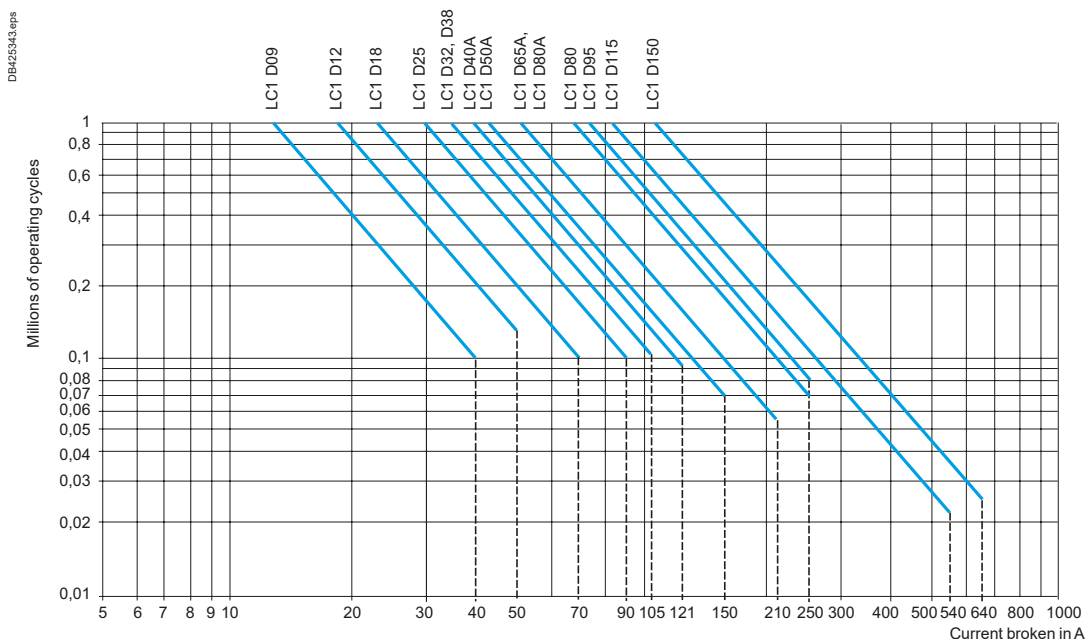

# TeSys contactors

For utilisation categories AC-2 or AC-4

## Selection - Coordination and standards

### Selection according to required electrical durability, in categories AC-2 or AC-4 ( $U_e \leq 440\text{ V}$ )

Control of 3-phase asynchronous squirrel cage motors (AC-4) or slip ring motors (AC-2) with breaking whilst motor stalled.  
The current broken ( $I_c$ ) in AC-4 is equal to  $6 \times I_e$ .  
( $I_e$  = rated operational current of the motor).

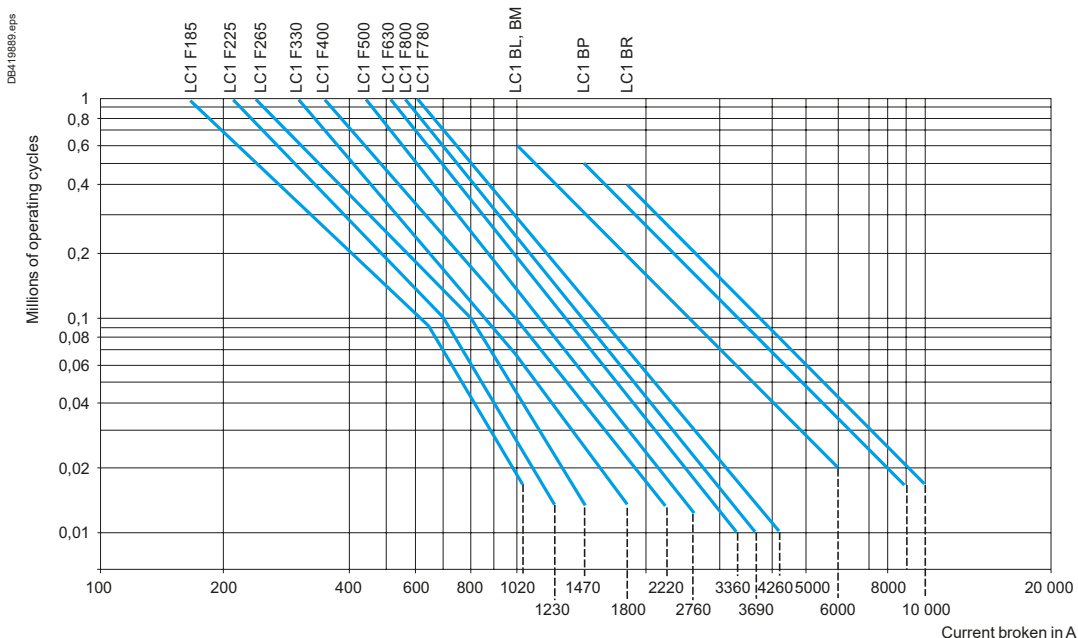

#### Example:

- asynchronous motor with  $P = 90\text{ kW}$  -  $U_e = 380\text{ V}$  -  $I_e = 170\text{ A}$ .  $I_c = 6 \times I_e = 1020\text{ A}$ .  
or asynchronous motor with  $P = 90\text{ kW}$  -  $U_e = 415\text{ V}$  -  $I_e = 165\text{ A}$ .  $I_c = 6 \times I_e = 990\text{ A}$ .
- 60 000 operating cycles required.
- the above selection curves show the contactor rating needed: LC1F265.

### Selection according to required electrical durability, use in category AC-4 ( $440\text{ V} < U_e \leq 690\text{ V}$ )

Control of 3-phase asynchronous squirrel cage motors with breaking whilst motor stalled.  
The current broken ( $I_c$ ) in AC-4 is equal to  $6 \times I_e$  ( $I_e$  = rated operational current of the motor).

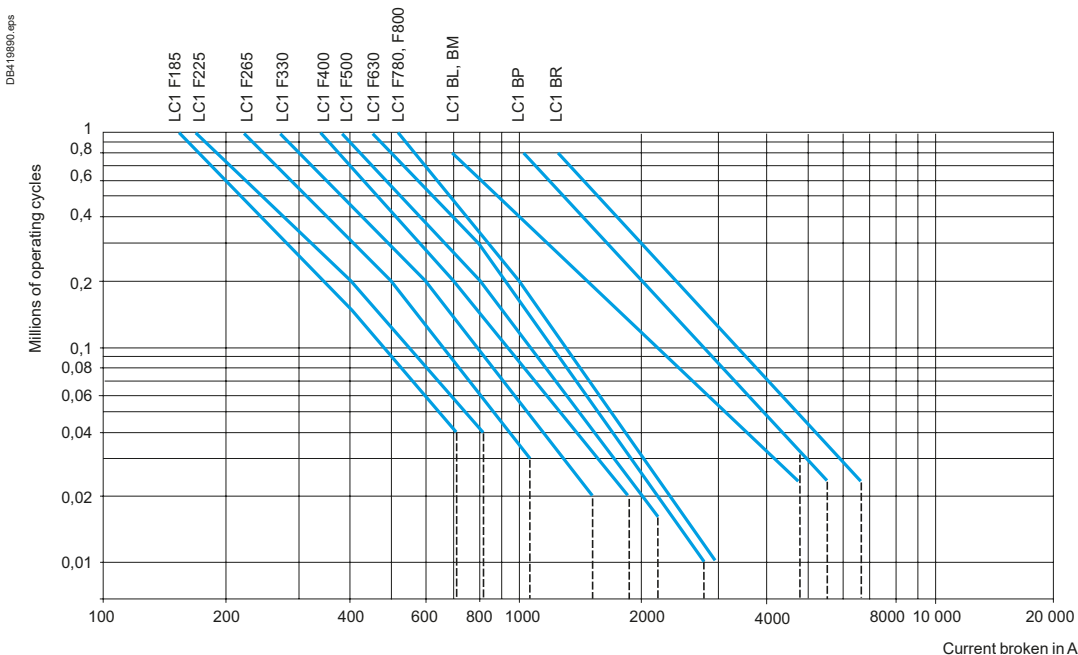

Coordination and standards

# TeSys contactors

For utilisation categories DC-1 to DC-5 <sup>(1)</sup>

## Selection - Coordination and standards

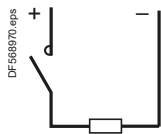

1 pole

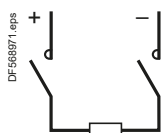

2 poles

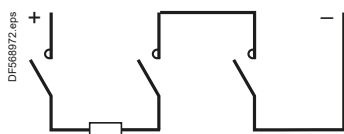

3 poles

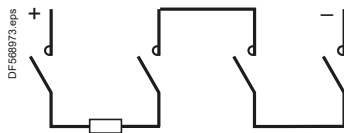

4 poles

### Rated operational current (Ie) in Amperes, in utilisation category DC-1, resistive loads: time constant $\frac{L}{R} \leq 1$ ms, ambient temperature $\leq 60$ °C

Rated operational voltage Ue V	No. of poles connected in series	Contactor rating <sup>(1)</sup>									
		LC1 D09	LC1 DT20	LC1 D12 DT25	LC1 D18 DT32	LC1 D25 DT40	LC1 D32	LC1 D38	LC1 D40A	LC1 DT60A	
24	1	20	20	20	25	32	40	40	50	50	
	2	20	20	20	25	32	40	40	50	50	
	3	20	20	20	25	32	40	40	50	50	
	4	–	20	20	25	32	–	–	–	50	
48/75	1	20	20	20	25	32	40	40	50	50	
	2	20	20	20	25	32	40	40	50	50	
	3	20	20	20	25	32	40	40	50	50	
	4	–	20	20	25	32	–	–	–	50	
125	1	4	4	4	4	7	7	7	7	7	
	2	20	20	20	25	32	40	40	50	50	
	3	20	20	20	25	32	40	40	50	50	
	4	–	20	20	25	32	–	–	–	50	
250	1	1	1	1	1	1	1	1	1	1	
	2	4	4	4	4	7	7	7	7	7	
	3	20	20	20	25	32	40	40	50	50	
	4	–	20	20	25	32	–	–	–	50	
300	3	4	4	4	4	7	7	7	7	–	
	4	–	20	20	25	32	–	–	–	50	
460	1	–	–	–	–	–	–	–	–	–	
	4	–	–	–	–	–	–	–	–	–	
900	2	–	–	–	–	–	–	–	–		
1200	3	–	–	–	–	–	–	–	–		
1500	4	–	–	–	–	–	–	–	–		

### Rated operational current (Ie) in Amperes, in utilisation category DC-2 to DC-5, inductive loads: time constant $\frac{L}{R} \leq 15$ ms, ambient temperature $\leq 60$ °C

Rated operational voltage Ue V	No. of poles connected in series	Contactor rating <sup>(1)</sup>									
		LC1 D09	LC1 DT20	LC1 D12 DT25	LC1 D18 DT32	LC1 D25 DT40	LC1 D32	LC1 D38	LC1 D40A	LC1 DT60A	
24	1	20	20	20	25	32	40	40	50	50	
	2	20	20	20	25	32	40	40	50	50	
	3	20	20	20	25	32	40	40	50	50	
	4	–	20	20	25	32	–	–	–	50	
48/75	1	20	20	20	25	32	40	40	50	50	
	2	20	20	20	25	32	40	40	50	50	
	3	20	20	20	25	32	40	40	50	50	
	4	–	20	20	25	32	–	–	–	50	
125	1	2	2	2	2	3	3	3	4	4	
	2	20	20	20	25	32	40	40	50	50	
	3	20	20	20	25	32	40	40	50	50	
	4	–	20	20	25	32	–	–	–	50	
250	1	0.5	0.5	0.5	0.5	0.5	0.5	0.5	1	1	
	2	2	2	2	2	3	3	3	4	4	
	3	8	8	8	8	32	40	40	50	50	
	4	–	20	20	25	32	–	–	–	50	
300	3	2	2	2	2	3	3	3	3	3	
	4	–	8	8	8	32	–	–	–	50	
460	1	–	–	–	–	–	–	–	–	–	
	4	–	–	–	–	–	–	–	–	–	
900	2	–	–	–	–	–	–	–	–		
1200	3	–	–	–	–	–	–	–	–		
1500	4	–	–	–	–	–	–	–	–		

<sup>(1)</sup> TeSys D Green contactors are not validated for DC-1 to DC-5 applications.

# TeSys contactors

For utilisation categories DC-1 to DC-5 <sup>(1)</sup>

## Selection - Coordination and standards

LC1 D50A	LC1 D65A D80A	LC1 DT80A D80	LC1 D80	LC1 D95	LC1 D115	LC1 D150	LC1 F185	LC1 F225	LC1 F265	LC1 F330	LC1 F400	LC1 F500	LC1 F630	LC1 F780	LC1 F800	LC1 BL	LC1 BM	LC1 BP	LC1 BR
65	65	65	100	100	200	200	240	260	300	360	430	580	850	1300	850	700	1100	1750	2400
65	65	65	100	100	200	200	240	260	300	360	430	580	850	1300	850	700	1100	1750	2400
65	65	65	100	100	200	200	240	260	300	360	430	580	850	1300	850	700	1100	1750	2400
-	-	65	100	-	200	-	240	260	300	360	430	580	850	1300	850	700	1100	1750	2400
65	65	65	100	100	200	200	240	260	300	360	430	580	850	1300	850	700	1100	1750	2400
65	65	65	100	100	200	200	240	260	300	360	430	580	850	1300	850	700	1100	1750	2400
65	65	65	100	100	200	200	240	260	300	360	430	580	850	1300	850	700	1100	1750	2400
-	-	65	100	-	200	-	240	260	300	360	430	580	850	1300	850	700	1100	1750	2400
7	7	7	12	12	12	12	210	230	270	320	380	520	760	1180	760	700	1100	1750	2400
65	65	65	100	100	200	200	210	230	270	320	380	520	760	1180	760	700	1100	1750	2400
65	65	65	100	100	200	200	240	260	300	360	430	580	850	1300	850	700	1100	1750	2400
-	-	65	100	-	200	-	240	260	300	360	430	580	850	1300	850	700	1100	1750	2400
1	1.5	1.5	2	2	10	10	-	-	-	-	-	-	-	-	-	700	1100	1750	2400
7	7	7	12	12	200	200	190	200	250	280	350	450	700	1000	700	700	1100	1750	2400
65	65	65	100	100	200	200	240	260	300	360	430	580	850	1300	850	700	1100	1750	2400
-	-	65	100	-	200	-	240	260	300	360	430	580	850	1300	850	700	1100	1750	2400
7	7	7	12	12	200	200	190	200	250	280	350	450	700	1000	700	700	1100	1750	2400
-	-	65	100	-	200	-	240	260	300	360	430	580	850	1000	850	700	1100	1750	2400
-	-	-	-	-	-	-	-	-	-	-	-	-	-	-	-	700	1100	1750	2400
-	-	-	-	-	200	-	190	200	250	280	350	450	700	1000	700	700	1100	1750	2400
-	-	-	-	-	-	-	-	-	-	-	-	-	-	-	-	700	1100	1750	2400
-	-	-	-	-	-	-	-	-	-	-	-	-	-	-	-	700	1100	1750	2400
-	-	-	-	-	-	-	-	-	-	-	-	-	-	-	-	700	1100	1750	2400

LC1 D50A	LC1 D65A D80A	LC1 DT80A D80	LC1 D80	LC1 D95	LC1 D115	LC1 D150	LC1 F185	LC1 F225	LC1 F265	LC1 F330	LC1 F400	LC1 F500	LC1 F630	LC1 F780	LC1 F800	LC1 BL	LC1 BM	LC1 BP	LC1 BR
65	65	65	100	100	200	200	240	260	300	360	430	580	850	1300	850	700	1100	1750	2400
65	65	65	100	100	200	200	240	260	300	360	430	580	850	1300	850	700	1100	1750	2400
65	65	65	100	100	200	200	240	260	300	360	430	580	850	1300	850	700	1100	1750	2400
-	-	65	100	-	200	-	240	260	300	360	430	580	850	1300	850	700	1100	1750	2400
65	65	65	100	100	200	200	240	260	300	360	430	580	850	1300	850	-	-	-	-
65	65	65	100	100	200	200	240	260	300	360	430	580	850	1300	850	700	1100	1750	2400
-	-	65	100	-	200	-	240	260	300	360	430	580	850	1300	850	700	1100	1750	2400
4	4	4	5	5	10	10	-	-	-	-	-	-	-	-	-	700	1100	1750	2400
65	65	65	100	100	200	200	160	180	250	300	350	500	700	1000	700	700	1100	1750	2400
65	65	65	100	100	200	200	240	240	280	310	350	550	850	1000	850	700	1100	1750	2400
-	-	65	100	-	200	-	240	240	280	310	350	550	850	1000	850	700	1100	1750	2400
1	1.5	1.5	1	1	3	3	-	-	-	-	-	-	-	-	-	700	1100	1750	2400
4	4	4	5	5	200	200	140	160	220	280	310	480	680	900	680	700	1100	1750	2400
65	65	65	100	100	200	200	160	180	250	300	350	500	700	1000	700	700	1100	1750	2400
-	-	65	100	-	200	-	240	260	300	360	430	580	850	1300	850	700	1100	1750	2400
3	3	3	5	5	200	200	140	160	220	280	310	480	680	900	680	700	1100	1750	2400
-	-	65	100	-	200	-	240	260	300	360	430	580	850	1300	850	700	1100	1750	2400
-	-	-	-	-	-	-	-	-	-	-	-	-	-	-	-	700	1100	1750	2400
-	-	-	-	-	200	-	140	160	220	280	310	480	680	800	680	700	1100	1750	2400
-	-	-	-	-	-	-	-	-	-	-	-	-	-	-	-	700	1100	1750	2400
-	-	-	-	-	-	-	-	-	-	-	-	-	-	-	-	700	1100	1750	2400
-	-	-	-	-	-	-	-	-	-	-	-	-	-	-	-	700	1100	1750	2400

Coordination and standards

## Selection according to required electrical durability, use in categories DC-1 to DC-5

The criteria for contactor selection are:

- the rated operational current  $I_e$
- the rated operational voltage  $U_e$
- the utilisation category and the time constant L/R
- the required electrical durability.

### Maximum operating rate (operating cycles)

The following limits must not be exceeded: 120 operating cycles/hour at rated operational current  $I_e$ .

### Electrical durability <sup>(1)</sup>

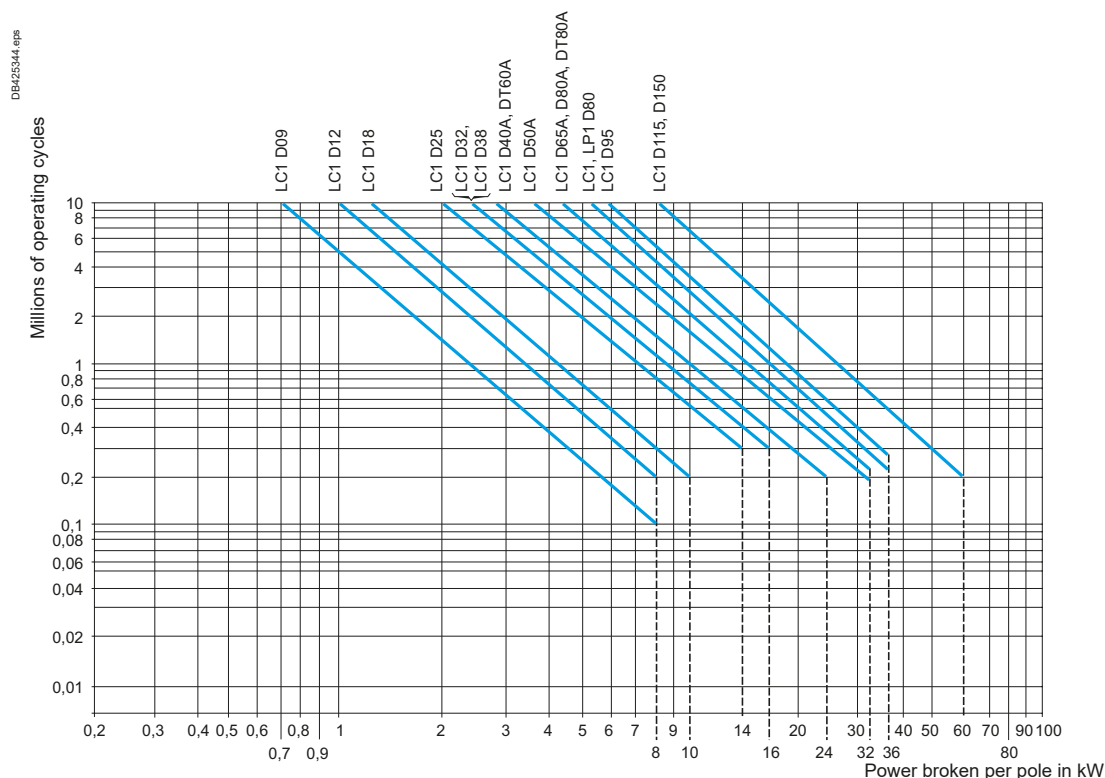

<sup>(1)</sup> TeSys D Green contactors are not validated for DC-1 to DC-5 applications

#### Example

Series wound motor -  $P = 1.5 \text{ kW}$  -  $U_e = 200 \text{ V}$  -  $I_e = 7.5 \text{ A}$ .

Utilisation: reversing, inching.

- Utilisation category = DC-5.
- Select contactor LC1D09 with 3 poles in series.
- The power broken is:  $P_c \text{ total} = 2.5 \times 200 \times 7.5 = 3.75 \text{ kW}$ .
- The power broken per pole is:  $1.25 \text{ kW}$ .
- The electrical durability read from the curve is  $\geq 3$  millions of operating cycles.

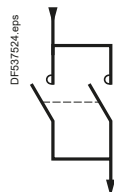

### Use of poles in parallel

Electrical durability can be increased by using poles connected in parallel.

With  $N$  poles connected in parallel, the electrical durability becomes: electrical durability read from the curves  $\times N \times 0.7$ .

#### Note:

When the poles are connected in parallel, the maximum operational currents indicated on pages A6/46 and A6/47 must not be exceeded.

#### Note:

Ensure that the connections are made in such a way as to equalise the currents in each pole.



### Selection according to required electrical durability, use in categories DC-1 to DC-5

#### Determining the electrical durability

The electrical durability can be read directly from the curves below, having previously calculated the power broken as follows:

$$P_{\text{broken}} = U_{\text{broken}} \times I_{\text{broken}}$$

The tables below give the values of  $U_c$  and  $I_c$  for the various utilisation categories.

Power broken			
Utilisation categories	U broken	I broken	P broken
DC-1 Non inductive or slightly inductive loads	$U_e$	$I_e$	$U_e \times I_e$
DC-2 Shunt wound motors, breaking whilst motor running	$0.1 U_e$	$I_e$	$0.1 U_e \times I_e$
DC-3 Shunt wound motors, reversing, inching	$U_e$	$2.5 I_e$	$U_e \times 2.5 I_e$
DC-4 Series wound motors, breaking whilst motor running	$0.3 U_e$	$I_e$	$0.3 U_e \times I_e$
DC-5 Series wound motors, reversing, inching	$U_e$	$2.5 I_e$	$U_e \times 2.5 I_e$

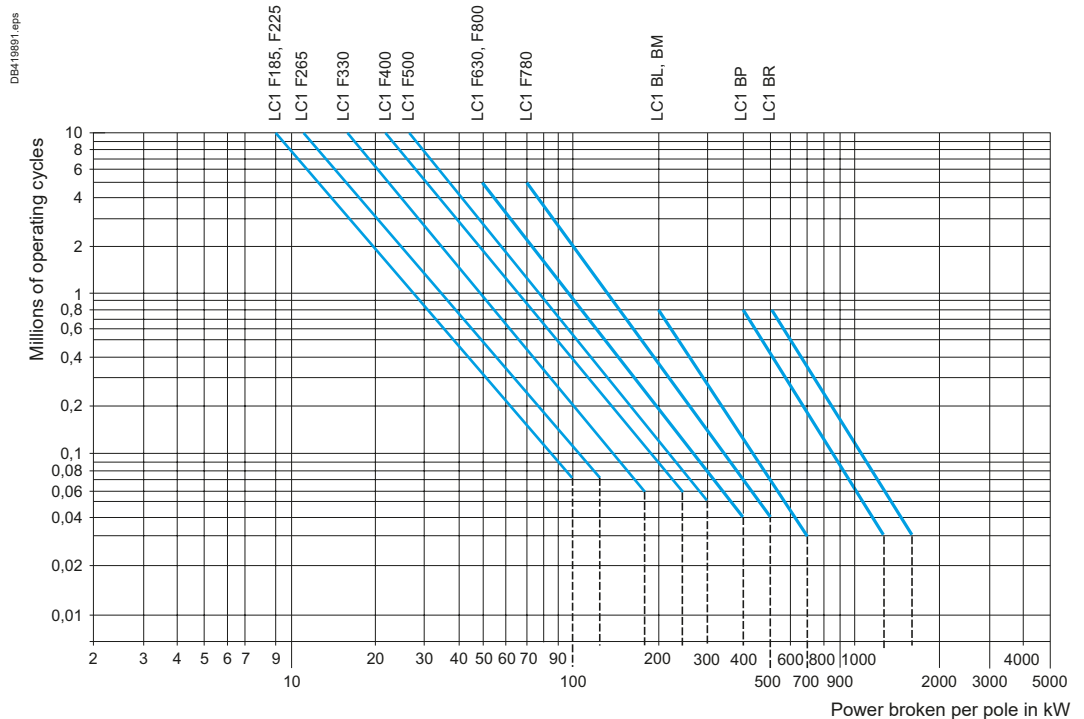

#### Example

Series wound motor:  $P = 40 \text{ kW}$  -  $U_e = 200 \text{ V}$  -  $I_e = 200 \text{ A}$ .

Utilisation: reversing, inching.

Utilisation category = DC-5.

- Select contactor LC1 F265 with 2 poles in series.
- The power broken is:  $P_c \text{ total} = 2.5 \times 200 \times 200 = 100 \text{ kW}$ .
- The power broken per pole is 50 kW.
- The electrical durability read from the curve is 500000 operating cycles.

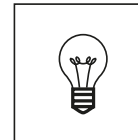

## General

The operating conditions of lighting circuits have the following characteristics:

- continuous duty: the switching device can remain closed for several days or even months
- a dispersion factor of 1: all luminaires in the same group are switched on or off simultaneously
- a relatively high temperature around the device due to the enclosure, the presence of fuses, or an unventilated control panel location.

This is why the operational current for lighting is lower than the value given for AC-1 duty.

## Protection

The continuous duty current drawn by a lighting circuit is constant. In fact:

- it is unlikely that the number of luminaires of an existing circuit will be modified
- this type of circuit cannot create an overload of long duration.

It is therefore only necessary to provide short-circuit protection.

This can be provided by:

- gG type fuses, or
- modular circuit breakers.

Nevertheless, it is always possible and sometimes more economical (smaller cable size) to protect the circuit by a thermal overload relay and associated aM type uses.

## Distribution system

### Single-phase circuit, 220/240 V

The tables on pages A6/51 to A6/55 are based on a single-phase 220/240 V circuit and can therefore be applied directly in this case.

### 3-phase circuit, 380/415 V (with neutral)

The total number of lamps (N) to be switched simultaneously is divided into three equal groups, each connected between one phase and neutral. The contactor can then be selected from the 220/240 V single-phase tables for a number of lamps equal to  $\frac{N}{3}$  lamps.

### 3-phase circuit, 220/240 V

The total number of lamps (N) to be switched simultaneously is divided into three equal groups, each connected between 2 phases (L1-L2), (L2-L3), (L3-L1).

The contactor can then be selected from the 220/240 V single-phase table for a number of lamps equal to  $\frac{N}{\sqrt{3}}$  lamps.

## Contactor selection tables

For the different types of lamps, the tables on pages A6/51 to A6/55 give the maximum number of lamps of unit power P (in Watts), which can be switched simultaneously for each size of contactor.

They are based on:

- a 220/240 V single-phase circuit
- an ambient temperature of 55 °C <sup>(2)</sup>, taking into account the operating conditions (see General paragraph)
- an electrical life of more than 10 years (200 days' operation per year).

They take into account:

- the total current drawn (including ballast)
- transient phenomena which occur at switch-on
- the starting currents and their duration
- the circulation of any harmonics which may be present.

### Lamps with compensating capacitor C (µF) connected in parallel

Parallel connected compensating capacitors C cause a current peak at the moment of switch-on. To ensure that the value of this current peak remains compatible with the making characteristics of the contactors, the unit value of the capacitance must not exceed the following:

Switching contactor rating <sup>(1)</sup>	LC1 K09	LP1 K09	LC1 D09	LC1 D12	LC1 D18	LC1 D25	LC1 D32	LC1 D38	LC1 D40A	LC1 D50A	LC1 D65A	LC1 D80A	LC1 D80
Maximum unit value C (µF) of parallel connected compensating capacitor	7	3	18	18	25	60	96	96	120	120	240	240	240

  

Switching contactor rating <sup>(1)</sup>	LC1 D80	LC1 D95	LC1 D115	LC1 D150	LC1 F185	LC1 F225	LC1 F265	LC1 F330	LC1 F400	LC1 F500	LC1 F630	LC1 F800
Maximum unit value C (µF) of parallel connected compensating capacitor	240	240	300	360	800	1200	1700	2500	4000	6000	9000	10800

This value is independent of the number of lamps switched by the contactor.

<sup>(1)</sup> Validation tests have not been carried out with TeSys D Green contactors.

<sup>(2)</sup> For an ambient temperature of 40 °C, multiply the number by 1.2.

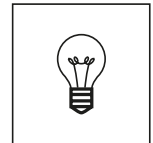

#### Usual values

The tables show the following values:

- IB: value of current drawn by each lamp at its rated voltage,
  - C: unit capacitance for each lamp,
- corresponding to the values normally quoted by lamp manufacturers.

These values are given for an ambient temperature of 55 °C (for 40 °C, multiply the number by 1.2).

Incandescent and halogen lamps										
P (W)	60	75	100	150	200	300	500	750	1000	
IB (A)	0.27	0.34	0.45	0.68	0.91	1.40	2.30	3.40	4.60	LC1 <sup>(1)</sup>
Max. no. of lamps according to P (W)	35	28	21	14	10	6	4	2	2	K09
	59	47	35	23	17	11	7	4	3	D09, D12
	77	61	46	30	23	15	9	6	4	D18
	92	73	55	36	27	18	11	7	5	D25
	129	103	77	51	38	25	15	10	7	D32, D38
	163	129	97	64	48	31	19	13	9	D40A
	207	164	124	82	62	40	24	16	12	D50A, D65A, D80A
	296	235	177	117	88	57	34	23	17	D80, D95
	430	340	256	170	126	82	50	34	24	D115
	466	370	280	184	138	90	54	36	26	D150
	710	564	426	282	210	136	82	56	40	F185
	770	610	462	304	228	148	90	60	44	F225
	888	704	532	352	262	170	104	70	52	F265
	1006	800	604	400	298	194	118	80	58	F330
	1274	1010	764	504	378	244	148	100	74	F400
	1718	1364	1030	682	508	330	200	136	100	F500
	2328	1850	1396	924	690	448	272	184	136	F630
	2776	2204	1666	1102	824	534	326	220	162	F800

Mixed lighting lamps						
P (W)	100	160	250	500	1000	
IB (A)	0.45	0.72	1.10	2.30	4.50	LC1 <sup>(1)</sup>
Max. no. of lamps according to P (W)	21	13	8	4	2	K09
	35	22	14	7	3	D09, D12
	46	29	18	9	4	D18
	55	36	23	11	5	D25
	77	48	30	15	7	D32, D38
	97	61	38	19	9	D40A
	124	77	49	24	12	D50A, D65A, D80A
	177	111	70	34	17	D80, D95
	256	160	104	50	26	D115
	280	174	114	54	28	D150
	426	266	174	82	42	F185
	462	288	188	90	46	F225
	532	332	218	104	52	F265
	604	378	246	118	60	F330
	764	478	312	150	76	F400
	1030	644	422	202	102	F500
	1398	874	572	272	140	F630
	1666	1040	680	326	166	F800

<sup>(1)</sup> Validation tests have not been carried out with TeSys D Green contactors.

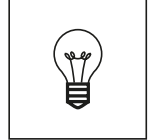

#### Usual values

The tables show the following values:

■ IB: value of current drawn by each lamp at its rated voltage

■ C: unit capacitance for each lamp

corresponding to the values normally quoted by lamp manufacturers.

These values are given for an ambient temperature of 55 °C (for 40 °C, multiply the number by 1.2).

Fluorescent lamps with starter. Single fitting												
	Non corrected				With parallel correction						LC1 <sup>(1)</sup>	
	P (W)	20	40	65	80	110	20	40	65	80		110
	IB (A)	0.39	0.45	0.70	0.80	1.2	0.17	0.26	0.42	0.52		0.72
	C (µF)	–	–	–	–	–	5	5	7	7	16	
Max. no. of lamps according to P (W)	24	21	13	12	8	56	36	22	18	–		K09
	41	35	22	20	13	94	61	38	30	22		D09, D12
	53	46	30	26	17	123	80	50	40	29		D18
	66	57	37	32	21	152	100	61	50	36		D25
	89	77	50	43	29	205	134	83	67	48		D32, D38
	112	97	62	55	36	258	169	104	84	61		D40A
	143	124	80	70	46	329	215	133	107	77		D50A, D65A, D80A
	205	177	114	100	66	470	367	190	153	111		D80, D95
	410	354	228	200	132	940	614	380	306	222		D115, D150
	492	426	274	240	160	1128	738	456	368	266		F185
	532	462	296	260	172	1224	800	490	400	288		F225
	614	532	342	300	200	1412	922	570	462	332		F265
	696	604	388	340	226	1600	1046	648	522	378		F330
	882	764	490	430	286	2024	1322	818	662	478		F400
	1190	1030	662	580	386	2728	1724	1104	892	644		F500
	1612	1398	698	786	524	3700	2418	1498	1210	874		F630, F800

Fluorescent lamps with starter. Twin fitting												
	Non corrected					With series correction					LC1 <sup>(1)</sup>	
	P (W)	2x20	2x40	2x65	2x80	2x110	2x20	2x40	2x65	2x80		2x110
	IB (A)	2x0.22	2x0.41	2x0.67	2x0.82	2x1.1	2x0.13	2x0.24	2x0.39	2x0.48		2x0.65
	C (µF)	–	–	–	–	–	–	–	–	–	–	
Max. no. of lamps according to P (W)	2x21	2x11	2x7	2x5	2x4	2x36	2x20	2x12	2x10	2x7		K09
	2x36	2x18	2x10	2x8	2x6	2x60	2x32	2x20	2x16	2x12		D09, D12
	2x46	2x24	2x14	2x12	2x8	2x80	2x42	2x26	2x20	2x16		D18
	2x58	2x30	2x18	2x14	2x10	2x100	2x54	2x32	2x26	2x20		D25
	2x78	2x42	2x26	2x20	2x14	2x134	2x72	2x44	2x36	2x26		D32, D38
	2x100	2x52	2x32	2x26	2x18	2x168	2x90	2x56	2x44	2x32		D40A
	2x126	2x68	2x40	2x34	2x24	2x214	2x116	2x70	2x58	2x42		D50A, D65A, D80A
	2x180	2x96	2x58	2x48	2x36	2x306	2x166	2x102	2x82	2x60		D80, D95
	2x360	2x194	2x118	2x96	2x72	2x614	2x332	2x204	2x166	2x122		D115, D150
	2x436	2x234	2x142	2x116	2x86	2x738	2x400	2x246	2x200	2x148		F185
	2x472	2x254	2x154	2x126	2x94	2x800	2x432	2x266	2x216	2x160		F225
	2x544	2x292	2x178	2x146	2x108	2x922	2x500	2x308	2x250	2x184		F265
	2x618	2x332	2x202	2x166	2x124	2x1046	2x566	2x348	2x282	2x208		F330
	2x782	2x420	2x256	2x210	2x156	2x1322	2x716	2x440	2x358	2x264		F400
	2x1054	2x566	2x346	2x282	2x210	2x1784	2x966	2x594	2x482	2x356		F500
	2x1430	2x766	2x468	2x384	2x286	2x2418	2x1310	2x806	2x654	2x484		F630, F800

<sup>(1)</sup> Validation tests have not been carried out with TeSys D Green contactors.

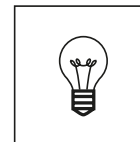

#### Usual values

The tables show the following values:

■ IB: value of current drawn by each lamp at its rated voltage

■ C: unit capacitance for each lamp

corresponding to the values normally quoted by lamp manufacturers.

These values are given for an ambient temperature of 55 °C (for 40 °C, multiply the number by 1.2).

#### Fluorescent lamps without starter. Single fitting

	Non corrected					With parallel correction					LC1 <sup>(1)</sup>	
	P (W)	20	40	65	80	110	20	40	65	80		110
	IB (A)	0.43	0.55	0.80	0.95	1.4	0.19	0.29	0.46	0.57		0.79
	C (μF)	–	–	–	–	–	5	5	7	7	16	
Max. no. of lamps according to P (W)	22	17	12	10	6	50	33	20	16	–	K09	
	37	29	20	16	11	84	55	34	28	20	D09, D12	
	48	38	26	22	15	110	72	45	36	26	D18	
	60	47	32	27	18	136	89	56	45	32	D25	
	97	63	43	36	25	184	101	76	61	44	D32, D38	
	102	80	55	46	31	231	151	95	77	55	D40A	
	130	101	70	58	40	294	193	121	98	70	D50A, D65A, D80A	
	186	145	100	84	57	421	275	173	140	101	D80, D95	
	372	290	200	168	114	842	550	346	280	202	D115, D150	
	446	348	240	202	136	1010	662	416	336	242	F185	
	484	378	260	218	148	1094	716	452	364	262	F225	
	558	436	300	252	170	1262	828	522	420	304	F265	
	632	494	340	286	194	1432	938	590	476	344	F330	
	800	624	430	362	246	1810	1186	748	604	434	F400	
	1078	844	580	488	330	2442	1600	1008	814	586	F500	
	1462	1144	786	662	448	3310	2168	1366	1104	796	F630, F800	

#### Fluorescent lamps without starter. Twin fitting

	Non corrected					With series correction					LC1 <sup>(1)</sup>	
	P (W)	2x20	2x40	2x65	2x80	2x110	2x20	2x40	2x65	2x80		2x110
	IB (A)	2x0.25	2x0.47	2x0.76	2x0.93	2x1.3	2x0.14	2x0.26	2x0.43	2x0.53		2x0.72
Max. no. of lamps according to P (W)	2x19	2x10	2x6	2x5	2x3	2x34	2x18	2x11	2x9	2x6	K09	
	2x32	2x16	2x10	2x8	2x6	2x56	2x30	2x18	2x14	2x10	D09, D12	
	2x42	2x22	2x12	2x10	2x8	2x74	2x40	2x24	2x18	2x14	D18	
	2x52	2x26	2x16	2x12	2x10	2x92	2x50	2x30	2x24	2x18	D25	
	2x70	2x36	2x22	2x18	2x12	2x124	2x66	2x40	2x32	2x24	D32, D38	
	2x88	2x46	2x28	2x22	2x16	2x156	2x84	2x50	2x40	2x30	D40A	
	2x112	2x58	2x36	2x30	2x20	2x200	2x106	2x64	2x52	2x38	D50A, D65A, D80A	
	2x160	2x84	2x52	2x42	2x30	2x234	2x152	2x92	2x74	2x54	D80, D95	
	2x320	2x170	2x104	2x86	2x60	2x570	2x306	2x186	2x150	2x110	D115, D150	
	2x384	2x204	2x126	2x102	2x74	2x686	2x368	2x222	2x180	2x132	F185	
	2x416	2x220	2x136	2x112	2x80	2x742	2x400	2x242	2x196	2x144	F225	
	2x480	2x254	2x158	2x128	2x92	2x856	2x462	2x278	2x226	2x166	F265	
	2x544	2x288	2x178	2x146	2x104	2x970	2x522	2x316	2x256	2x188	F330	
	2x688	2x366	2x226	2x184	2x132	2x1228	2x662	2x400	2x324	2x238	F400	
	2x928	2x494	2x304	2x248	2x178	2x1656	2x892	2x540	2x438	2x322	F500	
	2x1258	2x668	2x414	2x338	2x242	2x2246	2x1210	2x730	2x592	2x436	F630, F800	

<sup>(1)</sup> Validation tests have not been carried out with TeSys D Green contactors.

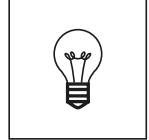

#### Usual values

The tables show the following values:

■ IB: value of current drawn by each lamp at its rated voltage

■ C: unit capacitance for each lamp

corresponding to the values normally quoted by lamp manufacturers.

These values are given for an ambient temperature of 55 °C (for 40 °C, multiply the number by 1.2).

Low pressure sodium vapour lamps																
Max. no. of lamps according to P (W)	Non corrected							With parallel correction								
	P (W)	35	55	90	135	150	180	200	35	55	90	135	150	180	200	
	IB (A)	1.2	1.6	2.4	3.1	3.2	3.3	3.4	0.3	0.4	0.6	0.9	1	1.2	1.3	
C (µF)	–	–	–	–	–	–	–	–	17	17	25	36	36	36	36	
																LC1 <sup>(1)</sup>
																K09
									40	30	–	–	–	–	–	D09, D12
									50	37	25	–	–	–	–	D18
									63	47	31	21	19	15	14	D25
									86	65	43	28	26	21	20	D32, D38
									110	82	55	36	33	27	25	D40A
									140	105	70	46	42	35	32	D50A, D65A, D80A
									200	150	100	66	60	50	46	D80, D95
									400	300	200	132	120	100	92	D115, D150
									560	420	280	186	168	140	128	F185
									606	454	302	202	182	152	140	F225
									700	524	350	232	210	174	162	F265
									792	594	396	264	238	198	182	F330
									1002	752	502	334	300	250	252	F400
									1352	1014	676	450	406	338	312	F500
									1982	1488	992	660	594	496	458	F630, F800

High pressure sodium vapour lamps												
Max. no. of lamps according to P (W)	Non corrected					With parallel correction						
	P (W)	150	250	400	700	1000	150	250	400	700	1000	
	IB (A)	1.9	3.2	5	8.8	12.4	0.84	1.4	2.2	3.9	5.5	
C (µF)	–	–	–	–	–	20	32	48	96	120		
												LC1 <sup>(1)</sup>
												K09
												D09, D12
												D18
												D25
												D32, D38
												D40A
												D50A, D65A, D80A
												D80, D95
												D115, D150
												F185
												F225
												F265
												F330
												F400
												F500
												F630, F800

(1) Validation tests have not been carried out with TeSys D Green contactors.

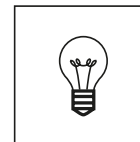

#### Usual values

The tables show the following values:

■ IB: value of current drawn by each lamp at its rated voltage

■ C: unit capacitance for each lamp

corresponding to the values normally quoted by lamp manufacturers.

These values are given for an ambient temperature of 55 °C (for 40 °C, multiply the number by 1.2).

High pressure mercury vapour lamps																
	Non corrected							With parallel correction								
	P (W)	50	80	125	250	400	700	1000	50	80	125	250	400	700	1000	
	IB (A)	0.54	0.81	1.20	2.30	4.10	6.80	9.90	0.3	0.45	0.67	1.3	2.3	3.8	5.5	
	C (µF)	–	–	–	–	–	–	–	10	10	10	18	25	40	60	
Max. no. of lamps according to P (W)	14	9	6	3	1	–	–	–	–	–	–	–	–	–	–	K09
	22	14	9	5	2	1	1	40	26	17	9	–	–	–	–	D09, D12
	27	18	12	6	3	2	1	50	33	22	11	6	–	–	–	D18
	35	23	15	8	4	2	1	63	42	28	14	8	5	3	–	D25
	48	32	21	11	6	3	2	86	57	38	20	11	6	4	–	D32, D38
	61	40	27	14	8	4	3	110	73	49	25	14	8	6	–	D40A
	77	51	34	17	10	6	4	140	93	62	32	18	11	7	–	D50A, D65A, D80A
	111	74	49	26	14	8	6	200	133	89	46	26	15	10	–	D80, D95
	222	148	100	52	28	16	12	400	266	178	92	52	30	20	–	D115, D150
	310	206	140	72	40	24	17	560	372	250	128	72	44	30	–	F185
	336	224	152	78	44	26	18	606	404	272	140	78	48	32	–	F225
	388	258	174	90	50	30	20	700	466	312	162	90	54	38	–	F265
	440	294	198	102	58	34	24	792	528	354	182	102	62	42	–	F330
	556	372	250	130	72	44	30	1002	668	448	232	130	78	54	–	F400
	752	500	338	176	98	60	40	1352	902	606	312	176	106	74	–	F500
1102	734	496	258	144	88	60	1982	1322	888	458	258	156	108	–	F630, F800	

Metal iodine vapour lamps										
	Non corrected				With parallel correction					
	P (W)	250	400	1000	2000	250	400	1000	2000	
	IB (A)	2.5	3.6	9.5	20	1.4	2	5.3	11.2	
	C (µF)	–	–	–	–	32	32	64	140	
Max. no. of lamps according to P (W)	3	2	–	–	–	–	–	–	–	K09
	4	3	1	–	–	–	–	–	–	D09, D12
	6	4	1	–	–	–	–	–	–	D18
	7	5	2	–	–	13	9	–	–	D25
	10	7	2	1	–	18	13	4	–	D32, D38
	13	9	3	1	–	23	16	6	–	D40A
	16	11	4	2	–	30	21	7	–	D50A, D65A, D80A
	24	16	6	3	–	42	30	11	5	D80, D95
	48	32	12	6	–	84	60	22	10	D115, D150
	66	46	18	8	–	120	84	32	14	F185
	72	50	20	10	–	130	90	34	16	F225
	84	58	22	12	–	150	104	40	18	F265
	94	66	24	14	–	170	118	44	20	F330
	120	84	32	16	–	214	150	56	26	F400
	162	112	42	20	–	290	202	76	36	F500
238	164	62	30	–	424	298	112	52	F630, F800	

(1) Validation tests have not been carried out with TeSys D Green contactors.

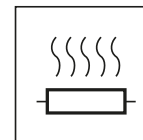

## Selection

### General

A heating circuit is a power switching circuit supplying one or more resistive heating elements switched by a contactor. The same general rules apply as for motor circuits, except that heating circuits are not normally subjected to overload currents. It is therefore only necessary to provide short-circuit protection.

### Characteristics of heating elements

The examples below are based on resistive heating elements used for industrial furnaces or for the heating of buildings (infra-red or resistive radiant type, convactor heaters, closed loop heating circuits, etc.). The variation in resistance values between hot and cold states causes a current peak at switch-on which never exceeds 2 to 3 times the rated operational current ( $I_n$ ). This initial peak does not recur during normal operation where subsequent switching is thermostatically controlled. The rated power and current of a heater are given for the normal operating temperature.

### Protection

The steady state current drawn by a heating circuit is constant when the voltage is stable. In fact:

- it is unlikely that the number of loads in an existing circuit will be modified
- this type of circuit cannot create overloads. It is therefore only necessary to provide short-circuit protection.

This can be provided by:

- gG type fuses, or
- modular circuit breakers.

Nevertheless, it is always possible and sometimes more economical (smaller cable size) to protect the circuit by a thermal overload relay and associated aM type fuses.

### Switching, control, protection

A heating element or group of heating elements of a given power may be either single-phase or 3-phase and may be supplied from a 220/127 V or a 400/230 V distribution system. Excluding a single-phase 127 V system (which is no longer commonly used), the following 3 types of circuit arrangement are possible:

- single-phase, 2-pole switching
- single-phase, 4-pole switching
- 3-phase switching

## Component selection according to the power switched

The combinations suggested below are based on an ambient temperature of 55 °C and for powers at the nominal voltage, but they also ensure switching in the event of prolonged overloads up to 1.05 Ue.

Single-phase, 2-pole switching				Contactor rating
Maximum power (kW)				
220/240 V	380/415 V	660/690 V	1000 V	
3.5	6.5	11	–	LC1, LP1K09
4.5	8	14	–	LC1D12
6	10.5	18.5	–	LC1D18
7	13	22.5	–	LC1D25
10	18	30.5	–	LC1D32, LC1D38
13	22.5	39.5	–	LC1D40A
16.5	28.5	43.5	–	LC1D65A, LC1D80A
24	42	73	82.5	LC1, LP1D80
44	76	118	157	LC1D115, LC1D150
48	83	130	–	LC1F185
52	90	145	–	LC1F225
60	104	160	210	LC1F265
75	130	200	250	LC1F330
86	145	230	300	LC1F4002
116	200	310	400	LC1F5002
170	290	450	695	LC1F6302, LC1F800
270	460	715	945	LC1F780
140	242	370	490	LC1BL32
220	380	580	770	LC1BM32
350	605	925	1225	LC1BP32
480	830	1270	1680	LC1BR32

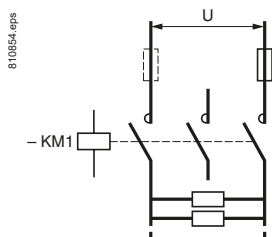

Circuit controlled by 2 poles of the contactor.



# TeSys contactors

For heating circuits

Selection - Coordination and standards

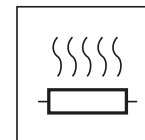

810856.eps

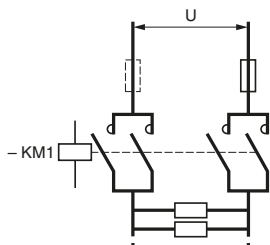

Circuit controlled by a 4-pole contactor with the poles parallel connected in pairs using appropriate connecting links. This solution enables the control of power values approximately equivalent to those controlled by the same contactor on 3-phase.

810857.eps

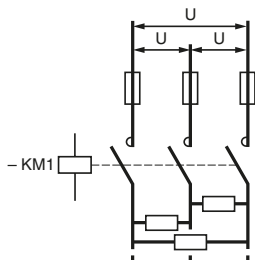

Circuit controlled by 3 poles of the contactor.

## Component selection according to the power switched

### Single-phase, 4-pole switching

Maximum power (kW)				Contactor rating
220/240 V	380/415 V	660/690 V	1000 V	
4.5	8	13.5	–	LC1, LP1K09004
7	13	22.5	–	LC1DT25
12	21	36.5	–	LC1DT40
26	45.5	79.5	–	LC1DT80A
38	66	117.5	132	LC1, LP1D80004
70	121	190	251	LC1D115004
76	132	202	–	LC1F1854
80	142	230	–	LC1F2254
96	166	253	335	LC1F2654
120	205	320	400	LC1F3304
137	236	363	480	LC1F4004
185	320	490	650	LC1F5004
272	470	718	950	LC1F6304
425	735	1140	1520	LC1F7804
224	387	590	785	LC1BL34
352	608	930	1230	LC1BM34
560	968	1478	1960	LC1BP34
768	1328	2025	2685	LC1BR34

### 3-phase switching

Maximum power (kW)				Contactor rating
220/240 V	380/415 V	660/690 V	1000 V	
4.5	8	13.5	–	LC1, LP1K09
7	13	22.5	–	LC1D12
10	18	30.5	–	LC1D18
13	22.5	39.5	–	LC1D25
18	31	52.5	–	LC1D32, LC1D38
22.5	38	68	–	LC1D40A
28.5	49	86	–	LC1D65A, LC1D80A
40.5	70.5	126	135.5	LC1, LP1D80
83	140	235	345	LC1D115, LC1D150
100	170	280	–	LC1F185
110	185	300	–	LC1F225
125	220	370	540	LC1F265
160	260	400	640	LC1F330
180	310	530	760	LC1F400
255	445	740	950	LC1F500
370	630	1000	1500	LC1F630, LC1F800
570	1000	1650	2400	LC1F780
242	419	640	850	LC1BL33
380	658	1005	1350	LC1BM33
606	1047	1600	2150	LC1BP33
830	1437	2200	2950	LC1BR33

### Application example

For a 220 V, 50 Hz, single-phase circuit supplying a total heating load of 12.5 kW. Select a 3-pole contactor **LC1D65A**.

(1) See complete contactor references on pages B8/8 to B8/13 or consult your Regional Sales Office.

Coordination  
and  
standards

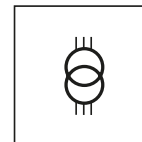

## Operating conditions

Maximum ambient temperature: 55 °C.

When a transformer is switched on, there is generally an initial current surge which reaches its peak value almost instantaneously and then decreases in a largely exponential manner to quickly reach its steady state value.

The value of this current depends on:

- the characteristics of the magnetic circuit and of the windings (cross sectional area of the core, rated inductance, number of turns, layout and size of the windings, ...)
- the performance of the magnetic laminations used
- the magnetic state of the circuit and the instantaneous value of the a.c. mains voltage at the moment of switch-on.

The inrush current at the moment of switch-on can reach 20 to 40 times the rated current for the various kVA power ratings in the tables below. This value is independent of the “no-load” or “on-load” state of the transformer.

## Contactor selection

The peak magnetising current of the transformer must be lower than the values given in the tables below.

Maximum operating rate: 120 operating cycles/hour.

Contactor rating <sup>(1)</sup>		LC1/ LP1 K06	LC1/ LP1 K09	LC1 D09	LC1 D12	LC1 D18	LC1 D25	LC1 D32	LC1 D38	LC1 D40A	LC1 D50A	LC1 D65A D80A	LC1 D80	LC1 D95	LC1 D115	LC1 D150	
Maximum permissible current peak at switch-on	A	160	225	350	350	420	630	770	770	1100	1250	1400	1550	1650	1800	2000	
Maximum operational power <sup>(2)</sup>	220 V	kVA	2	2.5	4	4	5	7	8.5	8.5	14	16	18	19.5	19.5	25	25
	240 V	kVA	2	2.5	4	4	5	7	8.5	8.5	14	16	18	19.5	19.5	25	25
	380 V	kVA	3.5	5	7	7	8	12.5	15	15	24	27	31	34	34	50	50
	400 V	kVA	3.5	5	7	7	8	12.5	15	15	24	27	31	34	34	50	50
	415 V	kVA	4	5.5	8	8	9	14	17	17	28	32	36	39	39	55	55
	440 V	kVA	4	5.5	8	8	9	14	17	17	28	32	36	39	39	55	55
500 V	kVA	5	7	9	9	11	16.5	20	20	32	36	40	45	45	65	65	
	660 V	kVA	6	8.5	12	12	14	21.5	26.5	26.5	42	48	53	59	59	80	80
	690 V	kVA	6	8.5	12	12	14	21.5	26.5	26.5	42	48	53	59	59	80	80
1000 V	kVA	-	-	-	-	-	-	-	-	-	-	85	95	100	100		

Contactor rating <sup>(1)</sup>		LC1 F185	LC1 F225	LC1 F265	LC1 F330	LP1 F400	LC1 F500	LC1 F630	LC1 F780	LC1 F800	LC1 BL	LC1 BM	LC1 BP	LC1 BR	
Maximum permissible current peak at switch-on	A	2900	3300	3800	5000	6300	7700	9000	12 000	11 000	18 000	18 000	24 000	30 000	
Maximum operational power <sup>(2)</sup>	220 V	kVA	40	45	50	65	75	100	120	175	145	230	230	300	380
	240 V	kVA	40	45	50	65	75	100	120	175	145	230	230	300	380
	380 V	kVA	75	80	90	120	130	170	200	280	245	400	400	530	660
	400 V	kVA	75	80	90	120	130	170	200	280	245	400	400	530	660
	415 V	kVA	80	90	100	130	140	190	220	310	270	450	450	560	700
	440 V	kVA	80	90	100	130	140	190	220	310	270	450	450	560	700
500 V	kVA	95	100	110	140	170	225	260	350	315	480	480	600	750	
	660 V	kVA	120	130	140	170	200	270	350	400	425	600	600	800	950
	690 V	kVA	120	130	140	170	200	270	350	400	425	600	600	800	950
1000 V	kVA	-	-	-	225	250	-	470	650	550	700	700	1000	1200	

(1) TeSys D Green contactors have not been validated for switching the primaries of 3-phase LV/LV transformers.

(2) Maximum operational power corresponding to a current peak at switch-on of 30 In.

# TeSys contactors <sup>(1)</sup>

For switching 3-phase capacitor banks used for power factor correction

Selection - Coordination and standards



## Standard contactors

Capacitors, together with the circuits to which they are connected, form oscillatory circuits which can, at the moment of switch-on, give rise to high transient currents (> 180 In) at high frequencies (1 to 15 kHz).

As a general rule, the peak current on energisation is lower when:

- the mains inductances are high
- the line transformer ratings are low
- the transformer short-circuit voltage is high
- the ratio between the sum of the ratings of the capacitors already switched into the circuit and that of the capacitor to be switched in is small (for multiple step capacitor banks).

In accordance with standards IEC 60070, NF C 54-100, VDE 0560, the switching contactor must be able to withstand a continuous current of 1.43 times the rated current of the capacitor bank step being switched.

The rated operational powers given in the tables below take this overload into account. Short-circuit protection is normally provided by gI type HPC fuses rated at 1.7 to 2 In.

## Contactor applications

### Operating conditions

Capacitors are directly switched. **The values of peak current at switch-on must not exceed the values indicated opposite.**

An inductor may be inserted in each of the three phases supplying the capacitors to reduce the peak current, if necessary.

Inductance values are determined according to the selected operating temperature.

### Power factor correction by a single-step capacitor bank

The use of a choke inductor is unnecessary: the inductance of the mains supply is adequate to limit the peak to a value compatible with the contactor characteristics.

### Power factor correction by a multiple-step capacitor bank

Select a special contactor as defined on page B8/20.

**If a standard contactor is used, it is essential to insert a choke inductor in each of the three phases of each step.**

## Maximum operational power of contactors

### Standard contactors

Maximum operating rate: 120 operating cycles/hour.

Electrical durability at maximum load: 100 000 operating cycles.

With choke inductors connected, where necessary.

Operational power at 50/60 Hz						Max. peak current	Contactor rating <sup>(1)</sup>
$\theta \leq 40\text{ }^\circ\text{C}$ <sup>(2)</sup>			$\theta \leq 55\text{ }^\circ\text{C}$ <sup>(2)</sup>				
220/240 V	400/440 V	600/690 V	220/240 V	400/440 V	600/690 V	A	
kvAR	kvAR	kvAR	kvAR	kvAR	kvAR		
6	11	15	6	11	15	560	LC1D09, D12
9	15	20	9	15	20	850	LC1D18
11	20	25	11	20	25	1600	LC1D25
14	25	30	14	25	30	1900	LC1D32, D38
17	30	37	17	30	37	2160	LC1D40
22	40	50	22	40	50	2160	LC1D50
22	40	50	22	40	50	3040	LC1D65
35	60	75	35	60	75	3040	LC1D80, D95
50	90	125	38	75	80	3100	LC1D115
60	110	135	40	85	90	3300	LC1D150
70	125	160	50	100	100	3500	LC1F185
80	140	190	60	110	110	4000	LC1F225
90	160	225	75	125	125	5000	LC1F265
100	190	275	85	140	165	6500	LC1F330
125	220	300	100	160	200	8000	LC1F400
180	300	400	125	220	300	10 000	LC1F500
250	400	600	190	350	500	12 000	LC1F630
250	400	600	190	350	500	14 200	LC1F800
200	350	500	180	350	500	25 000	LC1BL
300	550	650	250	500	600	25 000	LC1BM
500	850	950	400	750	750	25 000	LC1BP
600	1100	1300	500	1000	1000	25 000	LC1BR

<sup>(1)</sup> TeSys D Green contactors have not been validated for switching the primaries of 3-phase LV/LV transformers.

<sup>(2)</sup> Upper limit of temperature category conforming to IEC 60070.

# TeSys contactors (1)

For auto-transformer starting

Recommended wiring scheme, operation, curves

Coordination and standards

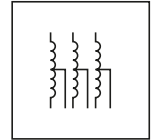

## Applications

Auto-transformer starting is suitable for starting all types of squirrel cage motors: with 3, 6 or even 9 terminals according to North American technology. Starting is performed at reduced voltage and produces maximum torque at minimum line current.

It allows the starting torque ( $C = f(U)^2$ ) to be adapted to the resistive torque of the driven machine by means of the 2 or 3 intermediate voltage take-off connections on the auto-transformer (0.65 and 0.8  $U_n$  or 0.5, 0.65 and 0.8  $U_n$ ). In general, only one take-off connection is used.

This type of starting is used for high power and/or high inertia machines. The motor is never disconnected from its power supply during starting (closed transition) and transient phenomena are eliminated.

## Recommended wiring scheme

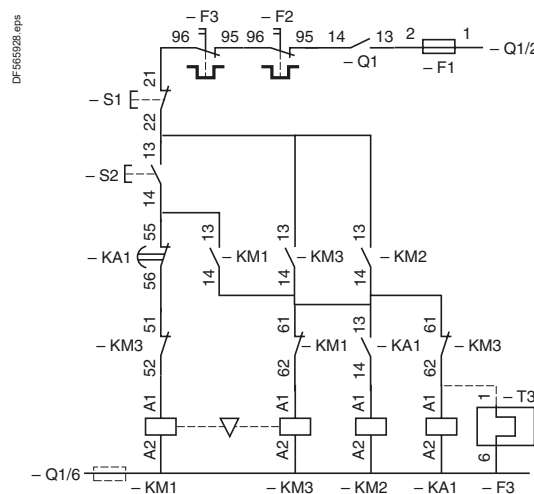
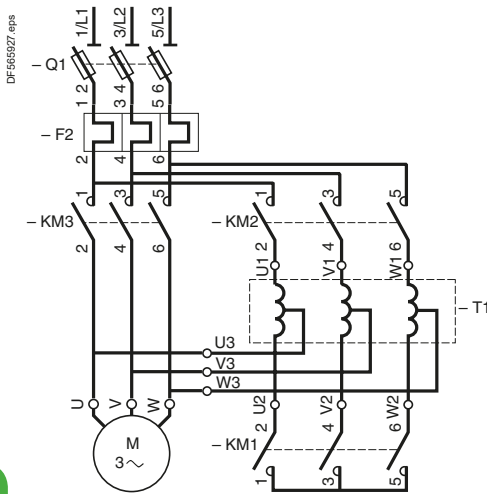

## Operation

Starting is performed in 3 stages:

- star connection of the auto-transformer is made by KM1, then contactor KM2 closes and the motor starts under reduced voltage
- the neutral point is opened by KM1; part of the auto-transformer winding is switched into each phase for a short moment, constituting a stator starting inductance
- KM3 switches the motor to full mains voltage and causes the auto-transformer to be shunted out of circuit by KM2.

The auto-transformer used generally has an air gap (adjusted or not) in order to obtain, during the second phase of starting, a series inductance whose value is compatible with correct starting.

## Operating curves

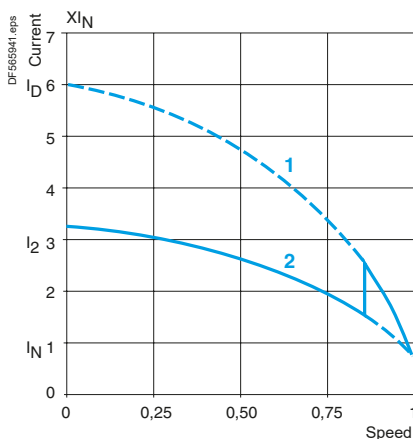

- 1 Direct switching current
- 2 Current with auto-transformer

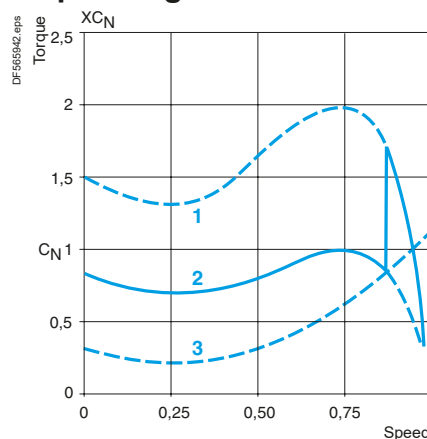

- 1 Direct motor torque
- 2 Torque with auto-transformer
- 3 Resistive torque of the machine

(1) TeSys D Green contactors have not been validated for auto-transformer starting.

# TeSys contactors <sup>(1)</sup>

For auto-transformer starting

Combination starters for customer assembly

Coordination and standards

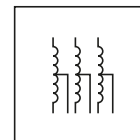

## Auto-transformer starters from 59 to 900 kW up to 440 V (type 1 coordination)

The components recommended in the table below have been determined according to the following characteristics:

- auto-transformer: on 0.65 Un connection with non adjusted air gap
- 3 starts per hour, of which 2 consecutive
- motor starting current:  $I_d/I_n = 6$
- $I_q = 70$  kA
- transient current on closing of KM3  $\leq 7 \sqrt{2} I_n$
- maximum starting time: 30 seconds
- ambient temperature  $\theta \leq 40$  °C.

Switch-disconnector-fuses: operators and accessories, please consult your Regional Sales Office.

Contactors: 3-pole.

LC1D: see pages B8/8 and B8/13,

LC1F: please consult your Regional Sales Office,

LC1B: please consult your Regional Sales Office.

Auxiliary contact blocks:

- for contactors LC1D: one LADN11 (1 N/O + 1 N/C) on KM1

- for contactors LC1F: one LADN22 (2 N/O + 2 N/C) on KM1, KM2 and KM3.

Thermal overload relays:

- LR: see pages B11/4 to B11/9

- LR9D: see pages B11/5 to B11/9

- LR9F: please consult your Regional Sales Office.

Standard power ratings of 3-phase motors 50/60 Hz in category AC-3					Switch-disconnector-fuse Reference	aM fuses		Contactors <sup>(1)</sup>			Overload relays	
220/230 V	380/400 V	415 V	440 V	In max		Size	Rating	KM3 LC1	KM2 LC1	KM1 LC1	Reference <sup>(2)</sup>	Setting range
kW	kW	kW	kW	A		A						A
30	55	59	59	105	GS•K	22 x 58	125	D115	D115	D3210	LR9D5369 LRD4367	90...150 95...120
40	75	80	80	138	GS•L	T0	160	D150	D115	D5011	LR9D5369 LRD4369	90...150 110...140
51	90	90	100	170	GS•N	T1	200	F185	D115	D5011	LR9F5371	132...220
63	110	110	110	205	GS•N	T1	250	F225	D150	D8011	LR9F5371	132...220
75	132	132	150	245	GS•N	T1	250	F265	F185	D115	LR9F7375	200...330
90	160	160	185	300	GS•QQ	T2	315	F330	F265	D115	LR9F7375	200...330
110	200	200	220	370	GS•QQ	T2	400	F400	F330	D115	LR9F7379	300...500
140	250	257	280	460	GS2S	T3	500	F500	F400	D115	LR9F7379	300...500
180	315	355	375	584	GS2S	T3	630	F630	F400	D185	LR9F7381	380...630
200	355	375	400	635	GS2V	T4	800	F800	F500	F185	TC800/1 + LRD05	505...800
220	400	425	450	710	GS2V	T4	800	F800	F500	F265	TC800/1 + LRD05	505...800
250	450	475	500	800	GS2V	T4	800	F800	F500	F265	TC1000/1 + LRD05	630...1000
280	500	530	560	900	GS2V	T4	1000	BM33•22	F630	F330	TC1000/1 LRD05	630...1000
315	560	600	630	1000	GS2V	T4	1000	BM33•22	F630	F400	TC1250/1 LRD05	790...1250
335	630	670	710	1100	GS2V	T4	1250	BP33•22	F630	F400	TC1250/1 LRD05	790...1250
400	710	750	800	1260	On base	T4	2 x 800 <sup>(3)</sup>	BP33•22	F780	F400	TC1500/1 LRD05	945...1500
450	800	800	800	1450	On base	T4	2 x 800 <sup>(3)</sup>	BP33•22	F780	F400	TC1750/1 LRD05	100...1750
500	900	900	900	1600	On base	T4	2 x 800 <sup>(3)</sup>	BR33•22	F780	F500	TC2000/1 LRD05	260...2000

<sup>(1)</sup> TeSys D Green contactors have not been validated for auto-transformer starting.

<sup>(2)</sup> For power ratings greater than or equal to 400 kW at 415 V, use one LRD-05 on the current transformer.

<sup>(3)</sup> Check with the motor manufacturer whether the fuses should be fitted in parallel.

# TeSys contactors <sup>(1)</sup>

For rotor circuits of slip-ring motors

Operation - Coordination and standards

## Applications

These contactors are used to eliminate starting resistance in the rotor circuit of slip-ring motors.

The most common application is for starters without inching and without rotor speed adjustment: pumps, fans, conveyors, compressors, ...

In the case of control by means of a manually operated master controller, the use of contactors with magnetic blow-out is recommended. Please consult your Regional Sales Office.

For hoisting applications, contactor selection must take into account the type of motor duty, the operating rate, the rotor voltage and current, the type of connection, the ambient temperature, etc.

Please consult your Regional Sales Office.

## Operation

The rotor circuit contactors are interlocked with the stator contactor and therefore do not open until after the stator contactor has opened, when the rotor voltage has disappeared, or virtually disappeared.

They make the current corresponding to the normal starting peak (1.5 to 2.5 times the rated rotor current) and open the circuit under no-load. Making and breaking are easy.

### Different types of rotor connection

#### Star connection

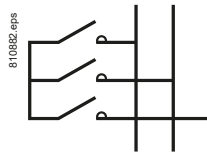

#### Delta connection

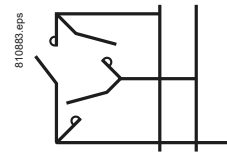

#### 'V' connection

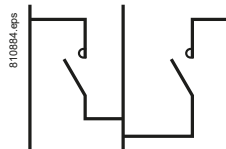

#### 'W' connection

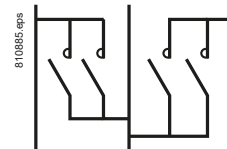

<sup>(1)</sup> TeSys D Green contactors have not been validated for rotor circuits of slip-ring motors.

# TeSys contactors <sup>(1)</sup>

For rotor circuits of slip-ring motors

## Selection - Coordination and standards

### Contactor selection according to the type of connection

#### Rotor current and voltage coefficients

Coefficients to be applied to the operational current values shown in the table below.

Type of connection	Rotor I coefficient	3-phase rotor U <sub>e</sub> <sup>(2)</sup>			
		Maximum	With counter-current		
	Operational I	LC1 F	LC1B	LC1 F	LC1B
Star	1	2000 V	2000 V	1000 V	1000 V
Delta	1.4	1700 V	1700 V	850 V	850 V
In V	1	1700 V	1700 V	850 V	850 V
In W	1.6	1700 V	1700 V	850 V	850 V

### Selection according to the operational current

The selection examples below take into account:

- a ratio of 2 between the maximum operational rotor voltage (U<sub>er</sub>) and the rated stator operational voltage (U<sub>es</sub>). This ratio is given in standard IEC 60947-4,
- a guarantee of occasional duty (making and breaking capacities) specified in the above standards.

Time current flowing	Contactor rating											
	LC1 D150	LC1 F185	LC1 F265	LC1 F400	LC1 F500	LC1 F630	LC1 F780	LC1 BL	LC1 BM	LC1 BP	LC1 BR	
<b>Intermediate contactor: with number of operating cycles ≤ 30/h</b>												
10 s	450 A	550 A	800 A	1100 A	1500 A	2000 A	2500 A	2000 A	2400 A	3750 A	5000 A	
30 s	280 A	400 A	550 A	730 A	1000 A	1500 A	2000 A	1200 A	1800 A	2600 A	3600 A	
60 s	220 A	300 A	400 A	550 A	750 A	1200 A	1500 A	1000 A	1500 A	2200 A	3000 A	

<b>Intermediate contactor: with number of operating cycles ≤ 60/h</b>												
5 s	450 A	550 A	800 A	1100 A	1500 A	2000 A	2500 A	2000 A	2400 A	3750 A	5000 A	
10 s	330 A	450 A	620 A	860 A	1250 A	1800 A	2300 A	1600 A	2200 A	3400 A	4500 A	
30 s	220 A	300 A	400 A	550 A	750 A	1200 A	1500 A	1000 A	1500 A	2200 A	3000 A	

<b>Intermediate contactor: with number of operating cycles ≤ 150/h for LC1F and 120/h for LC1B</b>												
5 s	300 A	420 A	580 A	820 A	1150 A	1650 A	2200 A	1500 A	2100 A	3200 A	4200 A	
10 s	250 A	350 A	430 A	600 A	850 A	1300 A	1600 A	1100 A	1600 A	2300 A	3200 A	

<b>Rotor short-circuit contactor and intermediate contactor: with number of operating cycles &gt; 150/h for LC1F and 120/h for LC1B</b>												
-	200 A	270 A	350 A	500 A	700 A	1000 A	1600 A	800 A	1250 A	2000 A	2750 A	

#### Electrical durability

For automatic starting, the electrical durability is in the region of 1 million operating cycles.

<sup>(1)</sup> TeSys D Green contactors have not been validated for rotor circuits of slip-ring motors.

<sup>(2)</sup> For use up to 3000 V, please consult your Regional Sales Office.

### Voltage drop caused by the inrush current

When the operating coil of a contactor is energised, the inrush current produces a voltage drop in the control circuit cable caused by the resistance of the conductors, which can adversely affect closing of the contactor.

An excessive voltage drop in the control supply cables (both a.c. and d.c.) can lead to non closure of the contactor poles or even destruction of the coil due to overheating.

This phenomenon is aggravated by:

- a long line
- a low control circuit voltage
- a cable with a small c.s.a.
- a high inrush power drawn by the coil.

The maximum length of cable, depending on the control voltage, the inrush power and the conductor c.s.a., is indicated in the graphs below.

### Remedial action

To reduce the voltage drop at switch-on:

- increase the conductor c.s.a.
- use a higher control circuit voltage
- use an intermediate control relay.

### Selection of conductor c.s.a.

These graphs are for a maximum line voltage drop of 5%. They give a direct indication of the copper conductor c.s.a. to be used for the control cable, depending on its length, the inrush power drawn by the contactor coil and the control circuit voltage (see example page A6/65).

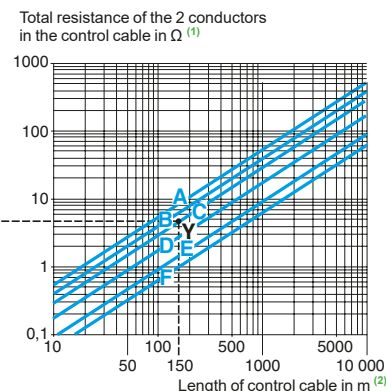
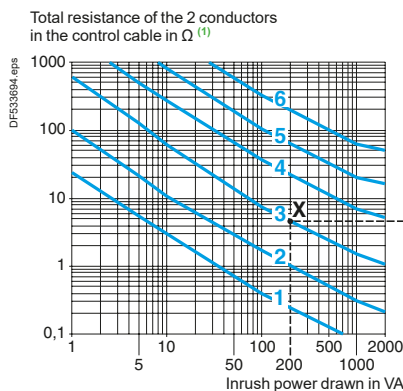

1 ~ 24 V    3 ~ 115 V    5 ~ 400 V

#### C.s.a. of copper cables

A 0.75 mm<sup>2</sup>    C 1.5 mm<sup>2</sup>    E 4 mm<sup>2</sup>

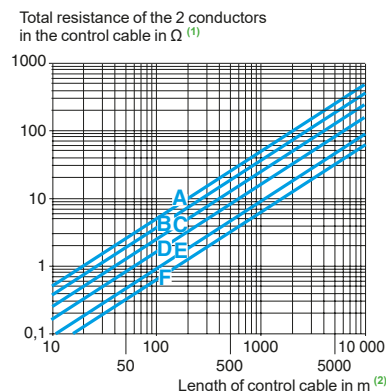
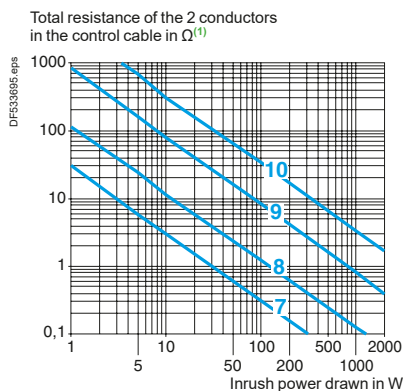

2 ~ 48 V    4 ~ 230 V    6 ~ 690 V

B 1 mm<sup>2</sup>    D 2.5 mm<sup>2</sup>    F 6 mm<sup>2</sup>

7 ~ 24 V    9 ~ 125 V  
 8 ~ 48 V    10 ~ 250 V

#### C.s.a. of copper cables

A 0.75 mm<sup>2</sup>    C 1.5 mm<sup>2</sup>    E 4 mm<sup>2</sup>  
 B 1 mm<sup>2</sup>    D 2.5 mm<sup>2</sup>    F 6 mm<sup>2</sup>

(1) For 3-wire control, the current only flows in 2 of the conductors.  
 (2) This is the length of the cable comprising 2 or 3 conductors. (Distance between the contactor and the control device).



### Voltage drop caused by the inrush current

What cable c.s.a. is required for the control circuit of an LC1 D40A, 115 V contactor, operated from a distance of 150 metres?

- Contactor LC1D40A, voltage 115 V, 50 Hz: inrush power: 200 VA.

On the left-hand graph on the page opposite, point X is at the intersection of the vertical line corresponding to 200 VA and the ~ 115 V voltage curve.

On the right-hand graph on the page opposite, point Y is at the intersection of the vertical line corresponding to 150 m and the horizontal line passing through point X.

Use the conductor c.s.a. indicated by the curve which passes through point Y, i.e.: 1.5 mm<sup>2</sup>.

If point Y lies between two c.s.a. curves, choose the larger of the c.s.a. values.

### Calculating the maximum cable length

The maximum permissible length for acceptable line voltage drop is calculated by the formula:

$$L = \frac{U^2}{SA} \cdot s \cdot K$$

where:

L : distance between the contactor and the control device in m  
 (length of the cable)

U : supply voltage in V

SA : apparent inrush power drawn by the coil in VA

s : conductor c.s.a. in mm<sup>2</sup>

K : factor given in the table below.

a.c. supply	SA in VA	20	40	100	150	200
	K	1.38	1.5	1.8	2	2.15
d.c. supply	Irrespective of the apparent inrush power SA, expressed in W K = 1.38					

**Residual current in the coil due to cable capacitance**

When the control contact of a contactor is opened, the control cable capacitance is effectively in series with the coil of the electromagnet. This capacitance can cause a residual current to be maintained in the coil, with the risk that the contactor will remain closed.

**This only applies to contactors operating on an a.c. supply.**

This phenomenon is aggravated by:

- a long line length between the coil control contact and the contactor, or between the coil control contact and the power supply,
- a high control circuit voltage,
- a low coil consumption, sealed,
- a low value of contactor drop-out voltage.

The maximum control cable length, according to the contactor coil supply voltage, is indicated in the graph on the page opposite.

**Remedial action**

Various solutions can be adopted to avoid the risk of the contactor remaining closed due to cable capacitance:

- use a d.c. control voltage, or
- add a rectifier, connected as shown in the scheme below, but retaining an a.c. operating coil: in this way, rectified a.c. current flows in the control cable.

When calculating the maximum cable length, take the resistance of the conductors into account.

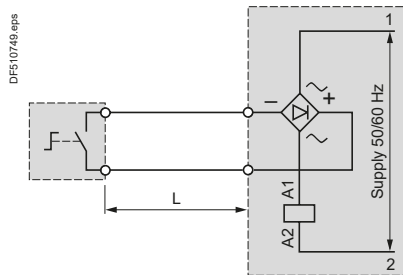

- Connect a resistor in parallel with the contactor coil <sup>(1)</sup>.

Value of the resistance:

$$R \Omega = \frac{1}{10^{-3} C (\mu F)} \quad (C \text{ capacitance of the control cable})$$

Power to be dissipated:

$$PW = \frac{U^2}{R}$$

<sup>(1)</sup> To avoid increasing the voltage drop due to inrush current, this resistor must be brought into operation after the contactor has closed by using an N/O contact.

### Residual current in the coil due to cable capacitance

These graphs are for a capacitance, between 2 conductors, of 0.2 µF/km. They make it possible to determine whether there is a risk of the contactor remaining closed due to the power drawn by the coil when sealed, as well as the control circuit voltage, according to the length of the control cable.

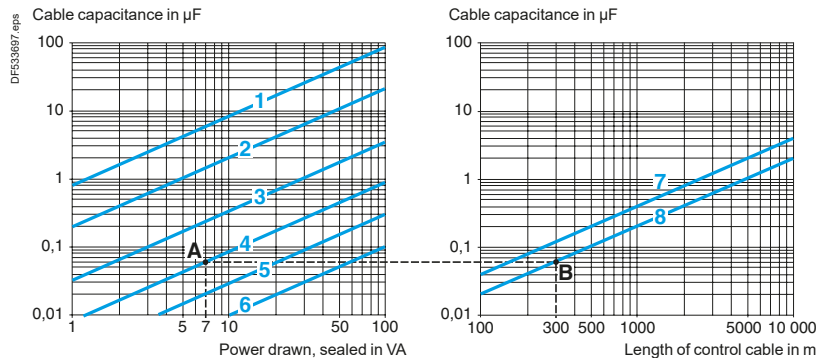

1 ~ 24 V	3 ~ 115 V	5 ~ 400 V	7 3-wire control
2 ~ 48 V	4 ~ 230 V	6 ~ 690 V	8 2-wire control

In the zones below the straight lines for 3-wire and 2-wire control respectively, there is a risk of the contactor remaining closed.

#### Examples

What is the maximum length for the control cable of an LC1D12 contactor, operating on 230 V, with 2-wire control?

- Contactor LC1D12, voltage 230 V, 50 Hz: power sealed 7 VA.

On the left-hand graph, point A is at the intersection of the vertical line for 7 VA with the ~ 230 V voltage curve.

On the right-hand graph, point B is at the intersection of the horizontal line with the 2-wire control curve.

The maximum cable length is therefore 300 m.

In the same example, with a 600 m cable, the point lies in the risk zone. A resistor must therefore be connected in parallel with the contactor coil.

$$R = \frac{1}{10^{-3} \cdot C} = \frac{1}{10^{-3} \cdot 0.12} = 8.3 \Omega$$

Value of this resistance:

$$P = \frac{U^2}{R} = \frac{(220)^2}{8300} = 6 \text{ W}$$

Power to be dissipated:

Alternative solution: use a d.c. control supply.

#### Calculating the cable length

The maximum permitted length of control cable to avoid the effects of capacitance is calculated using the formula:

$$L = 455 \cdot \frac{S}{U^2 \cdot C_0}$$

- L : distance between the contactor and the control device in km (length of the cable),
- S : apparent power, sealed, in VA,
- U : control voltage in V,
- C<sub>0</sub> : line capacitance of the cable in µF/km.

# Technical information

## Current of asynchronous squirrel cage motors at nominal load

### General - Coordination and standards

3-phase 4-pole motors				
Current values for power in kW				
Rated operational power <sup>(1)</sup>	Indicative rated operational current values at:			
	230 V	400 V	500 V	690 V
kW	A			
0.06	0.35	0.2	0.16	0.12
0.09	0.52	0.3	0.24	0.17
0.12	0.7	0.44	0.32	0.23
0.18	1	0.6	0.48	0.35
0.25	1.5	0.85	0.68	0.49
0.37	1.9	1.1	0.88	0.64
0.55	2.6	1.5	1.2	0.87
0.75	3.3	1.9	1.5	1.1
1.1	4.7	2.7	2.2	1.6
1.5	6.3	3.6	2.9	2.1
2.2	8.5	4.9	3.9	2.8
3	11.3	6.5	5.2	3.8
4	15	8.5	6.8	4.9
5.5	20	11.5	9.2	6.7
7.5	27	15.5	12.4	8.9
11	38	22	17.6	12.8
15	51	29	23	17
18.5	61	35	28	21
22	72	41	33	24
30	96	55	44	32
37	115	66	53	39
45	140	80	64	47
55	169	97	78	57
75	230	132	106	77
90	278	160	128	93
110	340	195	156	113
132	400	230	184	134
160	487	280	224	162
200	609	350	280	203
250	748	430	344	250
315	940	540	432	313
355	1061	610	488	354
400	1200	690	552	400
500	1478	850	680	493
560	1652	950	760	551
630	1844	1060	848	615
710	2070	1190	952	690
800	2340	1346	1076	780
900	2640	1518	1214	880
1000	2910	1673	1339	970

Current values for power in hp							
Rated operational power <sup>(2)</sup>	Indicative rated operational current values at:						
	110 - 120 V	200 V	208 V	220 - 240 V	380 - 415 V	440 - 480 V	550 - 600 V
hp	A						
1/2	4.4	2.5	2.4	2.2	1.3	1.1	0.9
3/4	6.4	3.7	3.5	3.2	1.8	1.6	1.3
1	8.4	4.8	4.6	4.2	2.3	2.1	1.7
1 1/2	12	6.9	6.6	6	3.3	3	2.4
2	13.6	7.8	7.5	6.8	4.3	3.4	2.7
3	19.2	11	10.6	9.6	6.1	4.8	3.9
5	30.4	17.5	16.7	15.2	9.7	7.6	6.1
7 1/2	44	25.3	24.2	22	14	11	9
10	56	32.2	30.8	28	18	14	11
15	84	48.3	46.2	42	27	21	17
20	108	62.1	59.4	54	34	27	22
25	136	78.2	74.8	68	44	34	27
30	160	92	88	80	51	40	32
40	208	120	114	104	66	52	41
50	260	150	143	130	83	65	52
60	-	177	169	154	103	77	62
75	-	221	211	192	128	96	77
100	-	285	273	248	165	124	99
125	-	359	343	312	208	156	125
150	-	414	396	360	240	180	144
200	-	552	528	480	320	240	192
250	-	-	-	604	403	302	242
300	-	-	-	722	482	361	289
350	-	-	-	828	560	414	336
400	-	-	-	954	636	477	382
450	-	-	-	1030	-	515	412
500	-	-	-	1180	786	590	472

(1) Values conforming to standard IEC 60072-1 (at 50 Hz).

(2) Values conforming to standard UL 508 (at 60 Hz).

**Note:** These values are given as a guide. They may vary depending on the type of motor, its polarity and the manufacturer.

## Standardisation

### Conformity to standards

Schneider Electric products satisfy, in the majority of cases, national (for example: BS in Great Britain, NF in France, DIN in Germany), European (for example: CENELEC) or international (IEC) standards. These product standards precisely define the performance of the designated products (such as IEC 60947 series for low voltage equipment).

When used correctly, as designated by the manufacturer and in accordance with regulations and correct practices, these products will allow users to build equipment, machine systems or installations that conform to their appropriate standards (for example: IEC 60204-1, relating to electrical equipment used on industrial machines).

Schneider Electric is able to provide proof of conformity of its production to the standards it has chosen to comply with, through its quality assurance system.

On request, and depending on the situation, Schneider Electric can provide the following:

- a declaration of conformity,
- a certificate of conformity (CB certificate, Asefa/Lovag),
- a homologation certificate or approval, in the countries where this procedure is required or for particular specifications, such as those existing in the merchant navy.

Standard	Certification authority		Country
	Name	Regulation authority	
ANSI	American National Standards Institute	ANSI	USA
BS	British Standards Institution	BSI	Great Britain
CEI	Comitato Elettrotecnico Italiano	CEI	Italy
DIN/VDE	Verband Deutscher Electrotechniker	VDE	Germany
EN	Comité Européen de Normalisation Electrotechnique	CENELEC	Europe
TR Regulation	Eurasian Customs Union	EAC	Russia, Belarus, Kazakhstan
IEC	International Electrotechnical Commission	IEC	Worldwide
JIS	Japanese Industrial Standards Committee	JISC	Japan
NBN	Institut Belge de Normalisation	IBN	Belgium
NEN	Nederlands Normalisatie Instituut	NNI	Netherlands
NF	Union Technique de l'Electricité	UTE	France
SAA	Standards Association of Australia	SAA	Australia
UNE	Asociacion Española de Normalizacion y Certificacion	AENOR	Spain

### European EN standards

These are technical specifications established in conjunction with, and with approval of, the relative bodies within the various CENELEC member countries (European Union, European Free Trade Association and many central and eastern European countries having «member» or «affiliated» status). Prepared in accordance with the principle of consensus, the European standards are the result of a weighted majority vote. Such adopted standards are then integrated into the national collection of standards, and contradictory national standards are withdrawn.

European standards incorporated within the French collection of standards carry the prefix NF EN. At the 'Union Technique de l'Electricité' (*Technical Union of Electricity*) (UTE), the French version of a corresponding European standard carries a dual number: European reference (NF EN ...) and classification index (C ...).

Therefore, the standard NF EN 60947-4-1 relating to motor contactors and starters, effectively constitutes the French version of the European standard EN 60947-4-1 and carries the UTE classification C 63-110.

This standard is identical to the British standard BS EN 60947-4-1 or the German standard DIN EN 60947-4-1.

Whenever reasonably practical, European standards reflect the international standards (IEC). With regard to automation system components and distribution equipment, in addition to complying with the requirements of French NF standards, Schneider Electric brand components conform to the standards of all other major industrial countries.

## Regulations

### European Directives

Opening up of European markets assumes harmonisation of the regulations pertaining to each of the member countries of the European Union.

The purpose of the European Directive is to eliminate obstacles hindering the free circulation of goods within the European Union, and it must be applied in all member countries. Member countries are obliged to transcribe each Directive into their national legislation and to simultaneously withdraw any contradictory regulations. The Directives, in particular those of a technical nature which concern us, only establish the objectives to be achieved, referred to as "essential requirements".

The manufacturer must take all the necessary measures to ensure that his products conform to the requirements of each Directive applicable to his production.

As a general rule, the manufacturer certifies conformity to the essential requirements of the Directive(s) for his product by affixing the CE marking.

The CE marking is affixed to Schneider Electric brand products concerned, in order to confirm compliance with French and European regulations.

#### Significance of the CE marking

- The CE marking affixed to a product signifies that the manufacturer declares that the product conforms to the relevant European Directive(s) which concern it; this condition must be met to allow free distribution and circulation within the countries of the European Union of any product subject to one or more of the E.U. Directives.
- The CE marking is intended solely for national market control authorities.
- The CE marking must not be confused with a conformity mark.

### European Directives

For electrical equipment, only conformity to standards signifies that the product is suitable for its designated function, and only the guarantee of an established manufacturer can provide a high level of quality assurance.

For Schneider Electric brand products, one or several Directives are likely to be applicable, depending on the product, and in particular:

- the Low Voltage Directive 2014/35/EU: the CE marking relating to this Directive has been compulsory since April 2016.
- the Electromagnetic Compatibility Directive 2014/30/EU: the CE marking on products covered by this Directive has been compulsory since April 2016.

### CB certificate, Asefa/Lovag certificate

- CB certification is issued according to IEC standards in respect to a multilateral agreement between almost industrial countries called CB scheme. It allows international certification of electrical and electronic products so that a single certification facilitates a worldwide market access.
- The function of ASEFA (Association des Stations d'Essais Française d'Appareils électriques - Association of French Testing Stations for Low Voltage Industrial Electrical Equipment) is to carry out tests of conformity to standards and to issue certificates of conformity and test reports. ASEFA laboratories are authorised by the French authorisation committee (COFRAC). ASEFA is now a member of the European agreement group LOVAG (Low Voltage Agreement Group). This means that any certificates issued by LOVAG/ASEFA are recognised by all the authorities which are members of the group and carry the same validity as those issued by any of the member authorities.

### Quality labels

When components can be used in domestic and similar applications, it is sometimes recommended that a "Quality label" be obtained, which is a form of certification of conformity.

Code	Quality label	Country
CEBEC	Comité Electrotechnique Belge	Belgium
KEMA-KEUR	Keuring van Electrotechnische Materialen	Netherlands
NF	Union Technique de l'Electricité	France
ÖVE	Österreichischer Verband für Electrotechnik	Austria
SEMKO	Svenska Elektriska Materiel Kontrollnatanalen	Sweden

### Product certifications

In some countries, the certification of certain electrical components is a legal requirement. In this case, a certificate of conformity to the standard is issued by the official test authority.

Each certified device must bear the relevant certification symbols when these are mandatory:

Code	Certification authority	Country
CSA	Canadian Standards Association	Canada
UL	Underwriters Laboratories	USA
CCC	China Compulsory Certification	China

Note on certifications issued by the Underwriters Laboratories (UL). There are two levels of approval:

- "Recognized" (UL)** The component is fully approved for inclusion in equipment built in a workshop, where the operating limits are known by the equipment manufacturer and where its use within such limits is acceptable by the Underwriters Laboratories.  
The component is not approved as a "Product for general use" because its manufacturing characteristics are incomplete or its application possibilities are limited.  
A "Recognized" component does not necessarily carry the certification symbol.
- "Listed" (UL)** The component conforms to all the requirements of the classification applicable to it and may therefore be used both as a "Product for general use" and as a component in assembled equipment. A "Listed" component must carry the certification.

### Marine classification societies

Prior recognition by certain marine classification societies is generally required for electrical equipment which is intended for use on board merchant vessels.

Europe community has emitted regulation No. 391/2009 for common rules for Type approval of Marine equipment.

MR TA Mutual Recognition Type Approval is a certificate that is mutually recognized by all 12 classification societies from the **EU RO MR group** (European Recognized Organizations). Renewal of marine certifications, or new products certification is now covered by EU-MR (Mutual Recognition) process and therefore removes the need for multiple marine certifications. Current EU RO members include all major societies like DNV-GL, BV, ABS, LR as well as non-European societies like CCS, KR, NK, RMRS, etc.

Rules	Classification authority	Country
ABS	American Bureau of Shipping	Unites States of America
KRoS	Korean register of Shipping	South Korea
BV	Bureau Veritas	France
DNV-GL	Det Norske Veritas - Germanischer Lloyd	Norway - Germany
LRoS	Lloyd's Register of Shipping	Great Britain
NKK	Nippon Kaiji Kyokai	Japan
RINA	Registro Italiano Navale	Italy
RMRoS	Russian Maritime Register of Shipping	Russia
CCS	China Classification Society	Republic of China

**Note:** for further details on a specific product, please refer to the "Characteristics" pages in this catalogue or consult your Regional Sales Office.

# Technical information

## Degrees of protection provided by enclosures IP code

### Introduction - Coordination and standards

#### Degrees of protection against the penetration of solid bodies, water and personnel access to live parts

The European standard EN 60529 dated October 1991, IEC publication 529 (2<sup>nd</sup> edition - November 1989), defines a coding system (IP code) for indicating the degree of protection provided by electrical equipment enclosures against accidental direct contact with live parts and against the ingress of solid foreign objects or water. This standard does not apply to protection against the risk of explosion or conditions such as humidity, corrosive gasses, fungi or vermin.

Certain equipment is designed to be mounted on an enclosure which will contribute towards achieving the required degree of protection (example : control devices mounted on an enclosure).















Different parts of an equipment can have different degrees of protection (example : enclosure with an opening in the base).

Standard NF C 15-100 (May 1991 edition), section 512, table 51 A, provides a cross-reference between the various degrees of protection and the environmental conditions classification, relating to the selection of equipment according to external factors.

Practical guide UTE C 15-103 shows, in the form of tables, the characteristics required for electrical equipment (including minimum degrees of protection), according to the locations in which they are installed.

### IP ●●● code

The IP code comprises **2 characteristic numerals** (e.g. **IP 55**) and may include **an additional letter** when the actual protection of personnel against direct contact with live parts is better than that indicated by the first numeral (e.g. IP 20C). Any characteristic numeral which is unspecified is replaced by an X (e.g. IP XXB).

1 <sup>st</sup> characteristic numeral		2 <sup>nd</sup> characteristic numeral		Additional letter	
corresponds to protection of the equipment against penetration of solid objects and protection of personnel against direct contact with live parts.		corresponds to protection of the equipment against penetration of water with harmful effects.		corresponds to protection of personnel against direct contact with live parts.	
Protection of the equipment	Protection of personnel				
<b>0</b> Non-protected	Non-protected	<b>0</b> Non-protected		<b>A</b>	With the back of the hand.
<b>1</b> Ø 50 mm 	Protected against the penetration of solid objects having a diameter greater than or equal to 50 mm.	Protected against direct contact with the back of the hand (accidental contacts).	<b>1</b> 	<b>B</b>	With the finger.
<b>2</b> Ø 12,5 mm 	Protected against the penetration of solid objects having a diameter greater than or equal to 12.5 mm.	Protected against direct finger contact.	<b>2</b> 15° 	<b>C</b>	With a Ø2.5 mm tool.
<b>3</b> Ø 2,5 mm 	Protected against the penetration of solid objects having a diameter greater than or equal to 2.5 mm.	Protected against direct contact with a Ø2.5 mm tool.	<b>3</b> 60° 	<b>D</b>	With a Ø1 mm wire.
<b>4</b> Ø 1 mm 	Protected against the penetration of solid objects having a diameter greater than or equal to 1 mm.	Protected against direct contact with a Ø1 mm wire.	<b>4</b> 		
<b>5</b> 	Dust protected (no harmful deposits).	Protected against direct contact with a Ø1 mm wire.	<b>5</b> 		
<b>6</b> 	Dust tight.	Protected against direct contact with a Ø1 mm wire.	<b>6</b> 		
			<b>7</b> 		
			<b>8</b> 		

Coordination and standards

# Technical information

## Degrees of protection provided by enclosures IK code

### Introduction - Coordination and standards

#### Degrees of protection against mechanical impact

The European standard EN 50102 dated March 1995 defines a coding system (IK code) for indicating the degree of protection provided by electrical equipment enclosures against external mechanical impact.

Standard NF C 15-100 (May 1991 edition), section 512, table 51 A, provides a cross-reference between the various degrees of protection and the environmental conditions classification, relating to the selection of equipment according to external factors.

Practical guide UTE C 15-103 shows, in the form of tables, the characteristics required for electrical equipment (including minimum degrees of protection), according to the locations in which they are installed.

#### IK ●● code

The IK code comprises **2 characteristic numerals** (e.g. **IK 05**).

#### 2 characteristic numerals

corresponding to a value of impact energy.

		h (cm)	Energy (J)
<b>00</b>	Non-protected		
<b>01</b>		7.5	0.15
<b>02</b>		10	0.2
<b>03</b>		17.5	0.35
<b>04</b>		25	0.5
<b>05</b>		35	0.7
<b>06</b>		20	1
<b>07</b>		40	2
<b>08</b>		30	5
<b>09</b>		20	10
<b>10</b>		40	20